

s::can
Intelligent. Optical. Online.

Manual

Spectrometer Probe V2

November 2011 Release



Table of Contents

1	General	
2	Safety Guidelines	
2.1	Declaration of Conformity	6
2.2	Special Hazard Warning	6
2.3	ATEX Certification	6
3	Technical Description	
3.1	Intended Use	7
3.2	Functional Principle	7
3.3	Product	8
3.4	Storage and Transport	10
3.5	Scope of Delivery	10
3.6	Product Updates, Other	10
4	Installation	
4.1	Environment	11
4.2	Mounting	11
4.2.1	Mounting with Probe Carrier	12
4.2.2	Mounting in Flow Cell Tap Water	14
4.2.3	Mounting in Flow Cell Autobrush	15
4.2.4	Mounting in Flow Cell Waste Water	15
4.3	Connection of Automatic Cleaning	16
5	Initial Startup	
5.1	Controller for Operation	17
5.2	Connection to the Controller	17
5.3	Probe Initialisation	17
5.3.1	Probe Initialisation using con::lyte	17
5.3.2	Probe Initialisation using ana::lyte / ana::pro	18
5.3.3	Probe Initialisation using moni::tool	19
5.4	Probe Parameterisation	20
5.4.1	Probe Parameterisation using con::lyte	23
5.4.2	Probe Parameterisation using ana::lyte / ana::pro	23
5.4.3	Probe Parameterisation using moni::tool	24
6	Calibration	
6.1	Types of Calibration	26
6.1.1	Offset Calibration with 1 Sample	26
6.1.2	Linear Calibration with 2 Samples	26
6.1.3	Linear Calibration with several Samples	26
6.1.4	Non Linear Calibration	27
6.2	Performing a Calibration	27
6.2.1	Calibration using con::lyte	27
6.2.2	Calibration G-Serie using ana::lyte / ana::pro	28
6.2.3	Calibration spectro::lyser using ana::lyte / ana::pro	29
6.2.4	Calibration using moni::tool	33
6.2.5	Multiple Sampling using moni::tool	34

7 Data Management

7.1	Data Storage	36
7.2	Data Transfer	36
7.3	Data Visualisation	36

8 Functional Check

8.1	Check of System	37
8.2	Check of Readings	38
8.3	Check of Probe - Sensor Integrity	39
8.4	Check of Probe - Linearity	40

9 Maintenance

9.1	Cleaning	41
9.2	Reference Measurement	42

10 Troubleshooting

10.1	Typical Error Pattern	43
10.2	Error Messages / Status Messages	44
10.3	Device Settings	49
10.3.1	Check / Modification of Device Settings using con::lyte	49
10.3.2	Check / Modification of Device Settings using ana::lyte / ana::pro	49
10.3.3	Check / Modification of Device Settings using moni::tool	50
10.4	Software Update	51
10.5	Return Consignment (RMA)	51

11 Accessories

11.1	Installation	52
11.1.1	Extension Cable	52
11.1.2	Spectrometer Probe Mounting (horizontal)	52
11.1.3	Spectrometer Probe Mounting (vertical)	53
11.1.4	Fixing Adapter	53
11.1.5	Flow Cell Setup Tap Water	54
11.1.6	Flow Cell Setup Autobrush	54
11.1.7	Flow Cell Setup Waste Water	55
11.1.8	System Panel micro::station	55
11.2	Automatic Cleaning	56
11.2.1	Pressure Connection Set	56
11.3	Maintenance	56
11.3.1	Cleaning Brushes	56
11.3.2	Cleaning Agent	56
11.3.3	Multifunctional Slide	57
11.4	Spare Parts	57
11.5	Optional Features	57
11.5.1	Pressure Sensor	57
11.5.2	Inserts	57

12 Technical Specifications

1 General

This manual contains, firstly, general information (chapter 1) and safety guidelines (chapter 2). The next chapter (chapter 3) provides a technical description of the s::can product itself as well as information regarding transport and storage of the product. In further chapters the installation (chapter 4) and the initial startup (chapter 5) are explained. Furthermore information regarding calibration of the device (chapter 6), data management (chapter 7), how to perform a functional check (chapter 8) and maintenance (chapter 9) can be found in this manual. Information regarding troubleshooting (chapter 10), the available accessories (chapter 11) and the technical specifications (chapter 12) complete the document.

Each term in this document that is marked *italic and underlined*, can be found on the display of your controller or as lettering on your s::can product.

In spite of careful elaboration this manual may contain errors or incompleteness. s::can does not assume liability for errors or loss of data due to such faults in the manual. The original manual is published in English and German by s::can. This original manual serves as the reference in case discrepancies occur in versions of the manual after translation into third languages.

This manual and all information and figures contained therein are copyrighted. All rights (publishing, reproduction, printing, translation, storage) are reserved by s::can Messtechnik GmbH. Each reproduction or utilisation outside the permitted limits of the copyright law is not allowed without previous written consent from s::can Messtechnik GmbH. The reproduction of product names, registered trade names, designation of goods etc. in this manual does not imply that these names can be used freely by everyone; often these are registered trade marks, even if they are not marked as such.

This manual, at the time of its publication (see release date printed on the top of this document), concerns the s::can products listed in chapter 3. Information and technical specifications regarding these items in s::can manuals from earlier release dates are herewith replaced by this manual.

2 Safety Guidelines



Installation, electrical connection, initial startup, operation and maintenance of any s::can product as well as complete s::can measuring systems must only be performed by qualified personnel. This qualified personnel has to be trained and authorised by the plant operator or by s::can for these activities. The qualified personnel must have read and understood this manual and have to follow the instructions contained in this manual.

For proper initial startup of complete s::can measuring systems, the manuals for the controller (con::lyte, con::stat, con::cube or PC / notebook with con::nect), the operating software (ana::lyte, ana::pro or moni::tool) as well as the connected probes and sensors have to be consulted.

The operator has to obtain the local operating permits and has to comply with the joint constraints associated with these. Additionally, the local legal requirements have to be observed (e.g. regarding safety of personnel and means of labour, disposal of products and materials, cleaning, environmental constraints). Before putting the measuring device into operation, the operator has to ensure that during mounting and initial startup – in case they are executed by the operator himself – the local legislation and requirements (e.g. regarding electrical connection) are observed.

All s::can products are leaving our factory in immaculate technical and safety conditions. Inappropriate or not intended use of the product, however, can cause danger! The manufacturer is not responsible for damage caused by incorrect or unauthorised use. Any kind of manipulation of the instrument is strictly prohibited - except for the activities described in this document. Conversions and changes to the device must not be made, otherwise all certifications and guarantee / warranty become invalid. For details regarding guarantee and warranty please refer to our general conditions of business.

Further safety guidelines for s::can spectrometer probes with ATEX certification, please refer to the specific notes for s::can Ex-spectrometer probe.

2.1 Declaration of Conformity

This s::can product has been developed, tested and manufactured for electromagnetic compatibility (EMC) and according to applicable European standards, as defined in the declaration of conformity.

CE-marks are applied on the device. The declaration of conformity related to this marking can be requested from s::can or your local s::can sales partner.

2.2 Special Hazard Warning

Because the s::can measuring systems are frequently installed in industrial and communal waste water applications, one has to take care during mounting and demounting of the system, as parts of the device can be contaminated with dangerous chemicals or pathogenic germs. All necessary precautions should be taken to prevent endangering of one's health during work with the measuring device.



The light source of the s::can spectrometer probe emits visible light as well as UV-light, which is extremely dangerous for human eyes (health hazard!). Do not look into the pulsed light beam (e.g. directly or by using mirrors)!



As internal parts of the s::can spectrometer probe are under high voltage, the opening of the probe's housing can cause injury, is strictly forbidden and will cancel all guarantee / warranty.

Further special hazard warnings for s::can spectrometer probe with ATEX certification, please refer to the specific notes for s::can Ex-spectrometer probe.

2.3 ATEX Certification

The s::can spectrometer probe can be manufactured according the ATEX Certification (ATEX stands for ATmosphere EXplosive). The appropriate documentation can be requested from s::can or your local sales partner. In case of ordering and / or operating an ATEX certified probe, in addition to this manual please refer the additional information contained in the specific notes for the s::can Ex-spectrometer probe.

3 Technical Description

3.1 Intended Use

All s::can spectrometer probes are compact spectrometer probes, capable of online measurements of absorption spectra (UV, UV-Vis or derived parameters) with high quality either directly submersed in liquid media (in-situ) or in by-pass via flow cell setup and. The probe can be operated also outside of the medium using a multifunctional slide. Applications range from ultra pure water (DOC > 0,01 mg/l) up to industrial waste water with CODs of several 1000 mg/l, and from single substance detection in sub-ppm concentrations up to surrogate and sum parameters in highest concentrations.

In all types of applications, the respective acceptable limits, which are provided in the technical specifications in the respective manuals, have to be observed. All applications falling outside of these limits, and which are not authorised by s::can Messtechnik GmbH in written form, do not fall under the manufacturer's liability.

The device must only be used for the purpose described in this manual. Use in applications not described in this manual, or modification of the device without written agreement from s::can, is not allowed. s::can is not liable for claims following from such unauthorised use. In such a case, the risks are the sole responsibility of the operator.

3.2 Functional Principle

Spectrometer probes work according to the principle of UV-Vis spectrometry. Substances contained in the medium to be measured weaken a light beam that moves through this medium. The light beam is emitted by a lamp, and after contact with the medium its intensity is measured by a detector over a range of wavelengths. Each molecule of a dissolved substance absorbs radiation at a certain and known wavelength. The concentration of substances contained determines the size of the absorption of the sample – the higher the concentration of a certain substance, the more it will weaken the light beam.

Extinction or absorbance stands for a ratio of two light intensities: The intensity of light after the beam passed through the medium to be measured and the intensity of light determined after the beam passed through a so-called reference medium (distilled water). There is a linear increase in absorption with higher concentrations.

Every s::can spectrometer probe consists of three main components: the emitter unit, the measuring section and the receiving unit.

The central element of the emitter is a light source – a xenon flash lamp. This is complemented by an optical system to guide the light beam and an electronic control system to operate the lamp.

In the measuring section the light passes through the space between the two measuring windows which is filled with the measuring medium and interacts with it. A second light beam within the probe – called compensation beam - is guided across an internal comparison section. Every s::can spectrometer probe is a dual-beam measuring instrument, allowing the automatic compensation of disturbances in the measuring process (e.g. ageing of the flash lamp).

The receiving unit is located on the side of the spectrometer probe where the probe cable is attached, and it consists of two major components: the detector and the operating electronics. An optical system focuses the measuring and compensation beams on the entrance port of the detector. The light received by the detector is split up into its wavelengths and guided to the 256 fixed photodiodes, making the use of sensitive moving components unnecessary. The operating electronics contained in this part of the probe are responsible for controlling the entire measuring process and all the various processing steps required to edit and check the measuring signal and to calculate fingerprints and parameters values.

3.3 Product

The s::can spectrometer probes are offered in two different device variants. On one hand the spectro::lyser, which provides the complete absorption spectrum and up to eight parameters derived out of it and on the other hand the s::can G-Series spectrometer probes, which work with the same measuring principle as the spectro::lyser but only provide up to four parameters and no absorption spectrum.

The single units of both s::can spectrometer probe variants can differ among themselves in the following specifications:

- Type of detector (UV-Vis or UV) / application (G-Serie)
- Length of the optical measuring path (OPL): 0.5 to 100 mm

The following device variants of the s::can spectrometer probe are available. Regarding detailed information of the device please refer to the technical specifications located at the end of this manual:

Item-no (see table below)	Type	Parameter
SP-x-yyy-p_-s-zz-nnn	spectro::lyser	depending on application (see section 5.4)
SP-x-yyy-p_-s-zz-nnn	spectro::lyser	depending on application (see section 5.4)
N2-x-yyy-p_-s-zz-nnn	nitro::lyser II	Turbidity / TSS + Nitrate
T2-x-yyy-p_-s-zz-nnn	color::lyser II	Turbidity + Color
U2-x-yyy-p_-s-zz-nnn	uv::lyser II	Turbidity / TSS + SAC254
O2-x-yyy-p_-s-zz-nnn	ozo::lyser II	Turbidity + Ozon
C2-x-yyy-p_-s-zz-nnn	carbo::lyser II	Turbidity / TSS + COD Turbidity / TSS + CODfilt. Turbidity / TSS + BOD Turbidity / TSS + SAC254 Turbidity / TSS + SAC254filt. Turbidity / TSS + TOC Turbidity / TSS + DOC
C3-x-yyy-p_-s-zz-nnn	carbo::lyser III	Turbidity / TSS + COD + CODf Turbidity / TSS + COD + BOD Turbidity / TSS + SAC254 + SAC254f Turbidity / TSS + TOC + DOC
M2-x-yyy-p_-s-zz-nnn	multi::lyser II	Nitrate + COD Nitrate + CODfilt. Nitrate + SAC254 Nitrate + SAC254filt. Nitrate + TOC Nitrate + DOC
M3-x-yyy-p_-s-zz-nnn	multi::lyser III	Nitrate + COD + CODfilt. Nitrate + SAC254 + SAC254f Nitrate + TOC + DOC
x = detector / application		
1 = UV-Vis detector	yyy = optical pathlength	p = internal pressure sensor
2 = UV detector	500 = 0.5 mm OPL	p0 = no pressure sensor
a = municipal waste water aeration basin	001 = 1.0 mm OPL	p1 = press.sensor 0.1 bar
d = drinking water	002 = 2.0 mm OPL	p2 = press.sensor 1 bar
e = municipal waste water effluent	005 = 5.0 mm OPL	p3 = press.sensor 10 bar
i = municipal waste water influent / sewage	035 = 35 mm OPL	
r = river water	100 = 100 mm OPL	
s = housing material		
s = stainless steel	zz = certification	nnn = probe cable
	NO = no specific certification	010 = 1.0 m probe cable
	06 = specification up to 6 bar (87 psi)	075 = 7.5 m probe cable
	12 = specification up to 12 bar (174 psi)	
	EX = Ex-proof version (only for SP-...-p0-..., not possible for SP-...-100-...)	

The device is typified by a type label, as shown on the right, that contains the following information:

- Manufacturer's name and country of origin
- Probe type
- Device serial number (S/N)
- Item number (Type)
- TAG number (can be entered by customer)
- Information on power supply
- Environment rating (IP)
- Acceptable temperature limits
- CE mark



- 1 Probe housing (lamp side)
- 2 Measuring section (optical measuring path)
- 3 Probe housing (detector side)
- 4 Connection for automatic cleaning
- 5 Cable gland
- 6 Probe cable

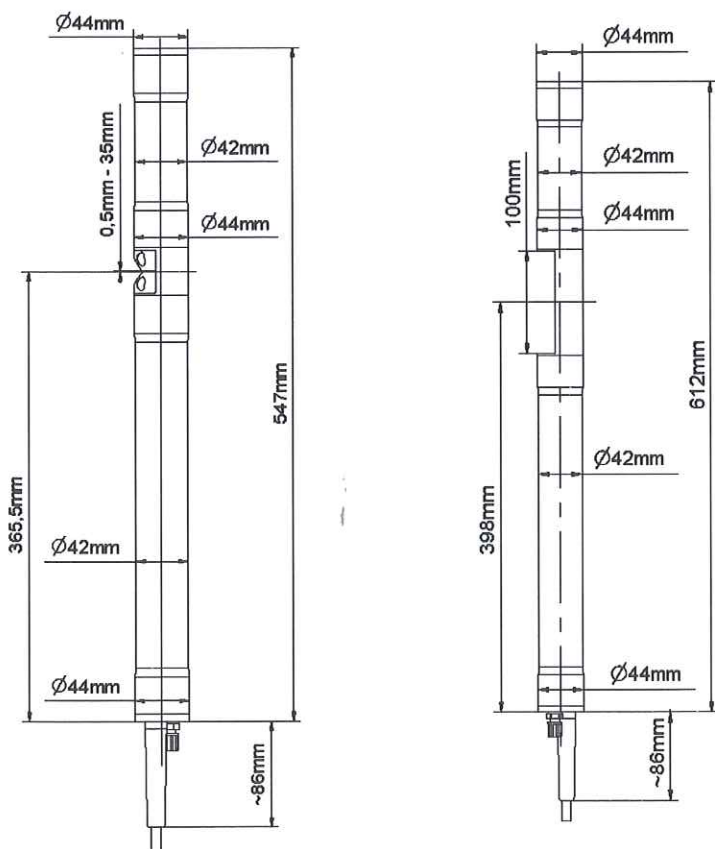

Dimension of probe in mm (OPL 0.5 - 35 mm left side and OPL 100 mm right side)

3.4 Storage and Transport

The temperature limits for device storage and transport, which are described in the section technical specifications, are to be observed at all times. The device shall not be exposed to strong impacts, mechanical loads or vibrations. The device should be kept free of corrosive or organic solvent vapours, nuclear radiation as well as strong electromagnetic radiation. Transport should be done in the original packaging if possible.

3.5 Scope of Delivery

Immediately upon receipt, please check the received consignment for completeness on the basis of the delivery note and check for any possible damage incurred during shipping. Please inform the delivering dispatcher and s::can immediately in case of any damages in transit.

The following parts should be included in the delivery:

- s::can spectrometer probe (item-no. according to section 3.3)
- Connection set for automatic cleaning (item-no. B-41-sensor)
- Cleaning brushes - 2 pieces (item-no. B-60-1 for OPL < 5 mm or B-60-2 for OPL > 2 mm)
- Multifunctional slide (item-no. E-421-1 for OPL 0.5 to 35 mm or E-421-2 for OPL = 100 mm)
- s::can manual spectrometer probe

The following parts could be included in the delivery if ordered as an option:

- Extension cable (item-no. C-210-spectro, C-220-spectro or C-230-spectro)
- Probe carrier (item-no. F-110-spectro for horizontal installation or F-120-spectro for vertical installation)
- Fixing adapter - stainless steel (item-no. F-15)
- Flow cell (item-no. F-445-1 for OPL 0.5 to 35 mm or F-445-2 for OPL 100 mm)
- Flow cell - autobrush (item-no. F-446-1 for OPL 35 mm or F-446-2 for OPL 100 mm)
- s::can compressor (item-no. B-32-230, B-32-110 or B-32-012)

In case of incompleteness please contact your s::can sales partner immediately!

3.6 Product Updates, Other

The manufacturer reserves the rights to implement, without prior notice, technical developments and modifications in the light of continuous product care.

4 Installation

4.1 Environment

As the correct installation of measuring instruments is an important prerequisite for satisfactory operation, s::can has prepared a checklist for the installation. This list can be used to ensure that all sources for potential operational problems can be ruled out to the greatest possible extent during installation, allowing the s::can monitoring system to operate properly.

Installation site:

- Favourable flow conditions (little turbulence, acceptable flow rate, etc.)
- Unadulterated measuring medium, no intrusion of contaminating substances (due to nutrient dosage or flocculants)
- Representative composition of sample with respect to the medium (process, thorough mixing etc.)
- Measuring medium is in equilibrium state, e.g. no gas release, no precipitation etc.
- No external interferences (i.e. no electric and electro-magnetic interferences by leakage current, earth fault of pumps, electric motors, high voltage currents, etc.)
- Easy accessibility (mounting, sampling, functional check, demounting)
- Availability of sufficient space (probe, sensor, installation fitting, controller, etc.)
- Adherence to limit values (see technical specifications located at the end of this manual)

Infrastructure (energy, data and compressed air):

- Power supply for controller (operational reliability, voltage, power)
- Oil- and particle free compressed-air supply (optional for automatic probe / sensor cleaning)
- Best possible weather and splash water proof set-up
- Shortest possible distances between system components (probe – controller – compressed-air supply – energy supply)
- Best possible layout of cables (non-buckling, working dependability, no damage etc.)

4.2 Mounting



When mounting the s::can spectrometer probe, please ensure that it is not possible that the measuring section (optical path) becomes blocked accidentally or by build-up of large particles present in the medium.

- Horizontal orientation (i.e. with measuring windows in vertical position) with plane face of the measuring section in vertical position. This will ensure no sedimentation of particles in the measuring section will take place and no gas bubbles will adhere to the measuring windows. The proper usage of an s::can probe carrier or s::can flow cell setup will ensure the correct position.
- Vertical orientation (i.e. with measuring windows in horizontal position) is only possible in applications with sufficient medium flow or automatic cleaning to ensure that no particles can sediment on the lower measuring window and no gas bubble might be captured within the measuring section. The proper usage of an s::can probe carrier will ensure the correct position.
- Recommendation: in case of installation in the aerated part of an activated sludge tank – the plane face of the optical path should be in horizontal position, with the measuring section facing up-wards.
- Flow velocity:
 - < 3 m/s to avoid cavitations and therefore deterioration of measuring quality
 - > 1 m/s when vertically mounted
- Abrasive solids (sand): < 1 g/l
- Recommended water level: > 10 cm at horizontal installation
- The housing must not be in direct contact with other metals, to prevent the possibility of contact corrosion.
- The probe cable has to be protected appropriately against cuts or damage induced by foreign objects in the water.
- In case of shallow water and / or low flow velocities the compressed-air cleaning system may swirl up sediments surrounding the measuring site (e.g. at the sewerage bottom). As a result the state of the measuring medium will not be representative of the normal water quality directly after cleaning. To avoid this from happening, the probe should be installed in such a way that the openings of the cleaning nozzles point towards the surface. This orientation is ensured when the cable gland is oriented above the connection for the automatic cleaning.



Even though the cable entry of the s::can spectrometer probes is equipped with a protective mechanism against forces along the axis of the probe, the probe cable must never bear the weight of the spectrometer probe!

For further information regarding installation of s::can spectrometer probes with ATEX certification, please refer to the specific notes for s::can Ex-spectrometer probe.

4.2.1 Mounting with Probe Carrier

The submersed installation of a spectrometer probe using the specific probe carrier (item-no. F-110-spectro or F-120-spectro) is performed by the following steps (see figures on the right hand side and below also):

- The shorter spacer ring [1] has to be placed on the cable side of the probe housing close to the measuring section with the red marking towards the optical path (please note the first 3 figures on the right hand side for correct positioning of the spacer ring).
- The longer spacer ring [2] has to be placed on the cable side of the probe housing close to the probe cable with the groove towards the optical path.
- After mounting the spacer rings, the compressed-air cleaning must be connection to the probe (see section 4.3).
- Subsequently, the probe cable and the compressed-air hose are inserted into the probe carrier (e.g. with the help of a cable pulling device); when doing so, the cable plug and cleaning hose end must be protected from becoming dirty. The delivered M5 hexagon socket screw [3] has to be placed in the provided tap hole, but should not be tightened yet.
- Now slide the spectrometer probe into the probe carrier, so that the spacer ring close to the measuring section juts out 1.5 cm of the edge of the carrier (see marking on the spacer). When using probe carrier for horizontal installation the probe has to be placed in such a way that the plane face of the measuring section has a perpendicular orientation so that there can be no sedimentation in the measuring section and so that air bubbles can escape upwards.
- The probe can now be fixed in this position by means of the hexagon socket screw [3], which will fall into the V-shaped groove of the spacer ring sitting on the end of the probe where the cable is located.

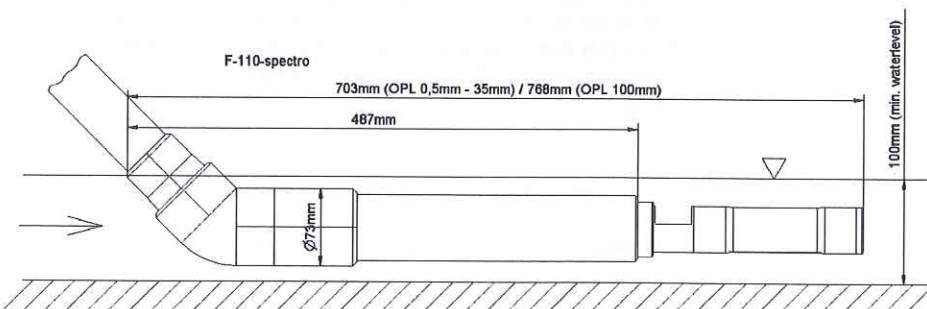
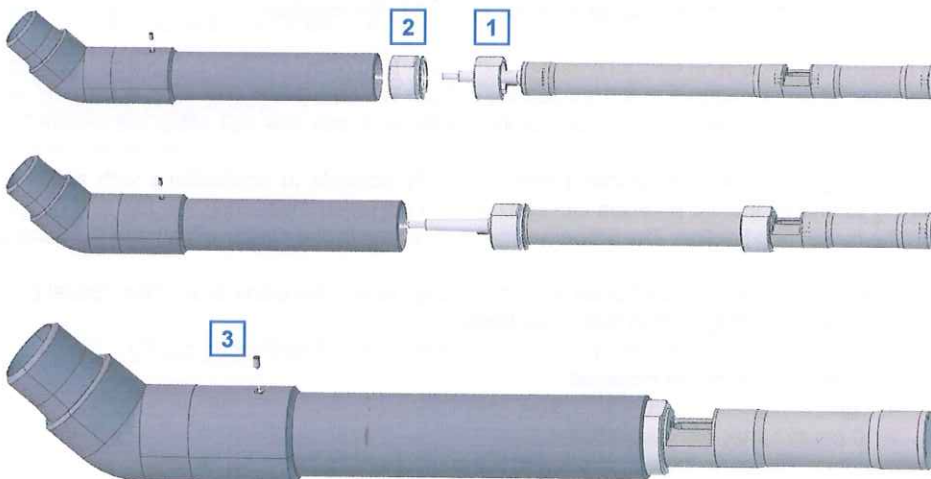
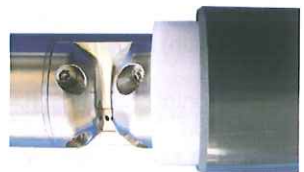

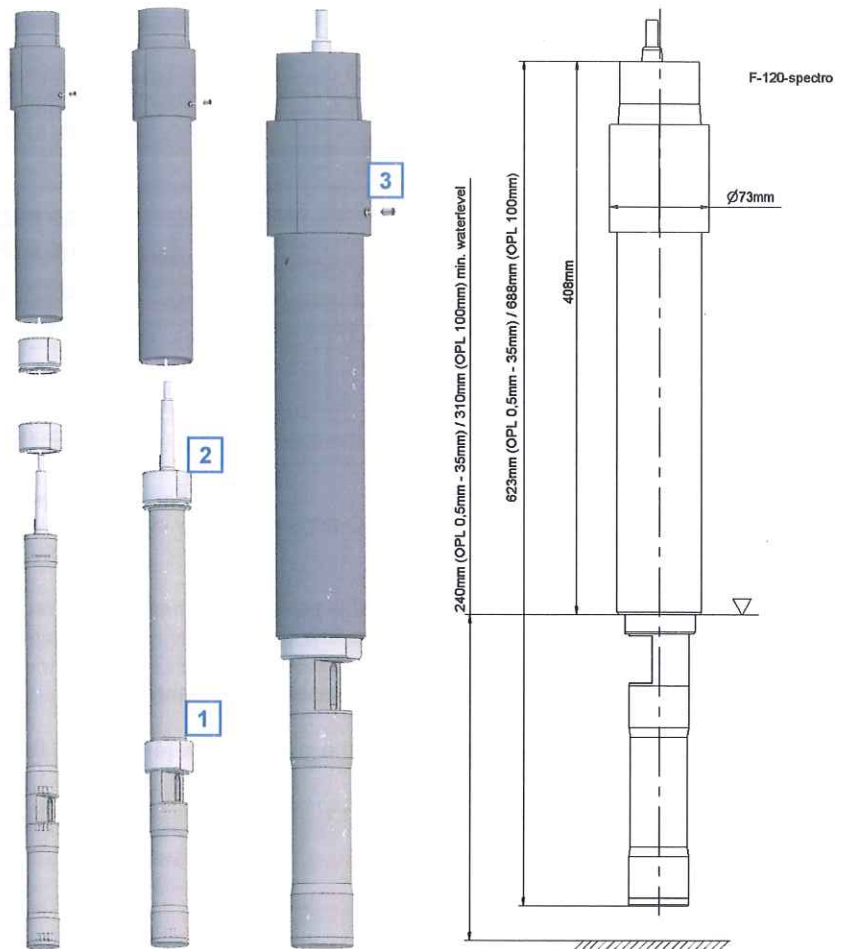

When necessary the probe carrier can be supplied with a tube extension that can simply be fixed to a railing by means of the fixing adapter (item-no. F-15). Appropriate measures must be taken to protect the probe cable and the compressed-air hose from damage due to buckling, abrasion etc. at the point where they exit the extension pipe.

For cleaning or checking the reference measurement (functional check) using the multifunctional slide, the spectrometer probe can be slid out of the probe carrier slightly after loosening of the hexagon socket [3].

4.2.2 Mounting in Flow Cell Tap Water

The flow cell can be mounted directly on a solid and flat surface (wall, mounting panel, etc.) using the mounting bracket (included in delivery). Once the mounting bracket is fixed the complete flow cell can easily be removed by unscrewing the safety screw (M4x45).



Please note, that the spectrometer probe can only be mounted in one way, because the measurement cell as well as the inside of the flow cell are not symmetrical. A red marking dot and a label on the flow cell indicate the position of the spectrometer probe in respect of the probe cable.



**probe cable
this side
Sondenkabel
diese Seite**

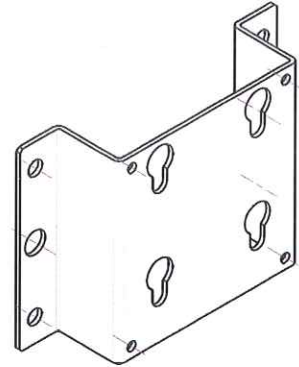

The installation of a spectrometer probe using the flow cell setup (item-no. F-445-1 or F-445-2) is performed by the following steps (see figures below also):

- Loosen both nuts [1], which compress the O-rings of the flow cell. Do not unscrew completely – the compression inserts [2] and O-rings [3] must stay in place.
- Insert the spectrometer probe so that the cable points to the marked side (red marking dot and label) and align, so that the optical path appears level and centred in the flow cell.
- Fasten both nuts [1] while holding the spectrometer probe firmly in place.
- Check the correct assembly by peering into the glass window [4] on top of the flow cell.
- For cleaning purposes the glass window [4] can be opened by removing the metal bracket [5] with a flat screw driver.

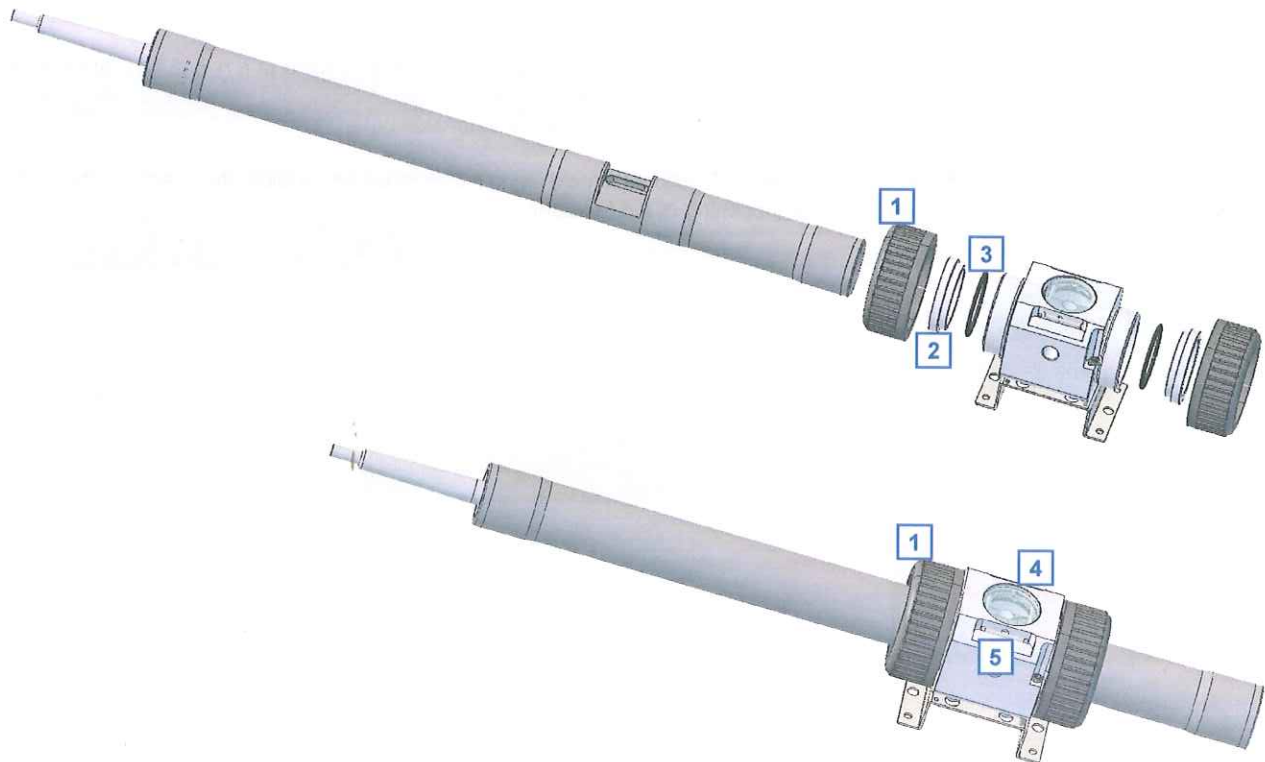

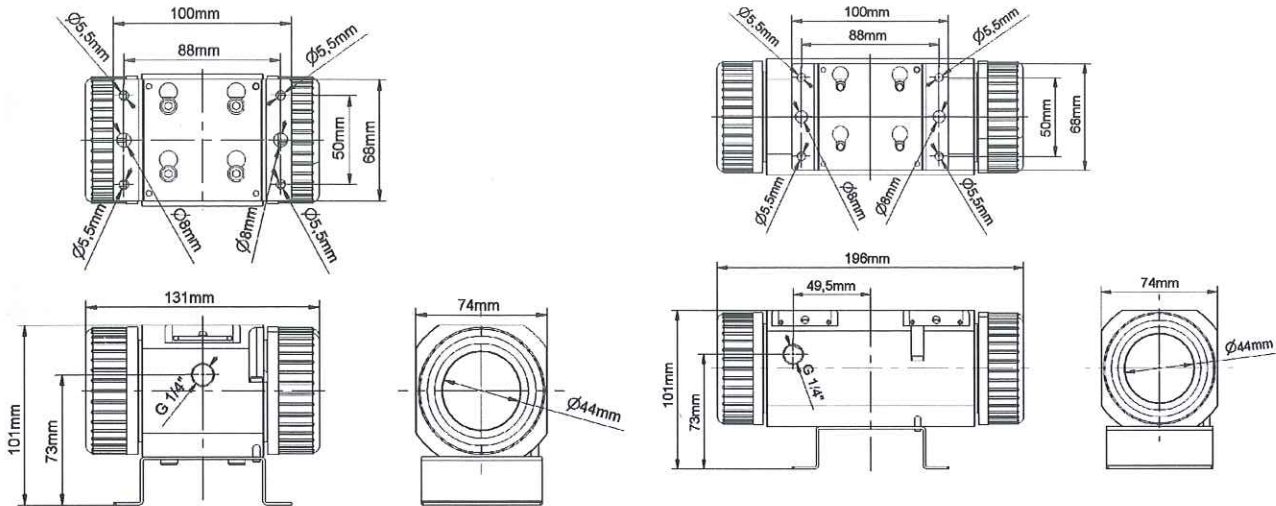

Dimension of flow cell (F-445-1 left and F-445-2 right)



For connection of the water supply use any fittings with 1/4 inch outside thread. To ensure that flow cell is always completely filled with water the medium supply has to be done vertically from bottom to top.

4.2.3 Mounting in Flow Cell Autobrush

Please refer to the separate s::can manual flow cell autobrush regarding correct installation of the spectrometer probe using this accessory.

4.2.4 Mounting in Flow Cell Waste Water

The installation of a spectrometer probe using the flow cell setup waste water (item-no. F-48-spectro) is performed by the following steps (see figures on the right side also):

- Loosen both nuts [1], which compress the O-rings of the flow cell. Do not unscrew completely – the compression inserts [2] and O-rings [3] must stay in place.
- Insert the spectrometer probe so that the optical path appears level and centred in the flow cell.
- Fasten both nuts [1] while holding the spectrometer probe firmly in place.
- Check the correct assembly by peering into the glass window [4].
- For cleaning purposes the glass window [4] can be opened by removing the metal bracket [5] with a flat screw driver.

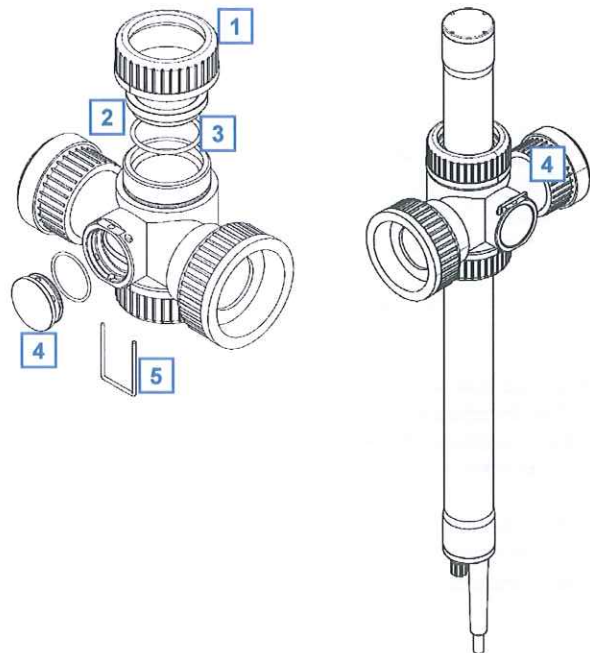

4.3 Connection of Automatic Cleaning

The compressed air connection set supplied with the system contains components necessary to connect the probe cleaning located on top of the spectrometer probe to the cleaning valve. The compressed air connection is performed by the following steps (see pictures on the right hand side also):

- Remove dummy insert [1] from pressure connection on top of probe by unscrewing the connecting nut [2] and removing the conical part [3].
- Put the connecting nut [2] and the conical part [3] over the cleaning hose.
- Push the cleaning hose over the pressure connection on top of the probe (warm up cleaning hose in hot water if necessary).
- Fasten connecting nut [2] by hand.
- A compressed air hose (to be provided by customer, ID 8 mm to 9 mm, UV- / ozone resistant) must be used to connect the adapter fitting of the pressure connection set to the output side of the cleaning valve (marked with Δ). Fasten the air hose with hose clamps.
- Another air hose and DIN 7.2 compressed air coupling are required to hook up the compressed air supply to the input side of the cleaning valve (marked with ∇).

The cleaning valve should never be connected to the compressed air coupling of your compressor directly, i.e. without a pressure hose in between. The total length of hoses should be as short as possible to avoid unnecessary pressure loss. In special occasions, drinking water may be used to operate the hydraulic-pneumatic cleaning appliance instead or compressed air – for more information please contact your local s::can sales partner.

Any foreign matter in the compressed air supply may impair the hydraulic-pneumatic cleaning process.

If you have any doubts about the purity of the air used (contamination by particles, oil, etc.), please install an appropriate filter upstream from the solenoid valve.

In areas with extremely low outside air temperature, s::can recommends laying the compressed air hoses such that they remain frost-free to prevent freezing of condensed water in the compressed air hose.

Please note that depending on the s::can probe and sensor type you are using, different maximum allowed pressures may be specified. In case a central pressurised air supply is used in such a case the lowest maximum allowed pressure amongst those specified for the individual instruments is to be used to supply all instruments or the use of pressure reducing valves to supply each instrument with the correct pressure is necessary.

In order to ensure proper operation of automatic cleaning s::can highly recommends to use s::can compressor optimized for compressed air supply of all probes and sensors.

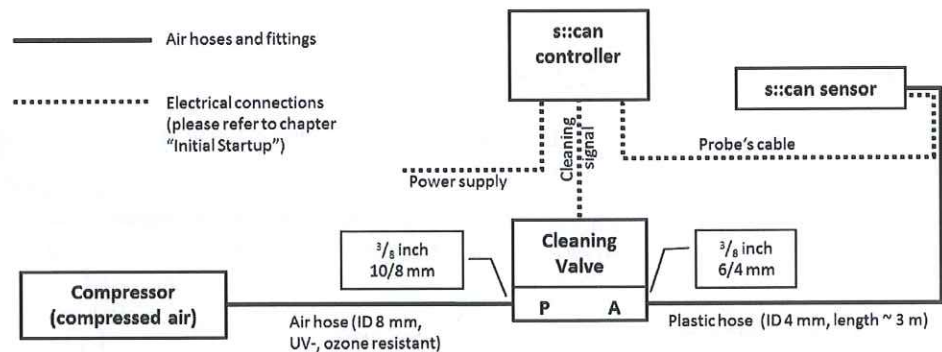
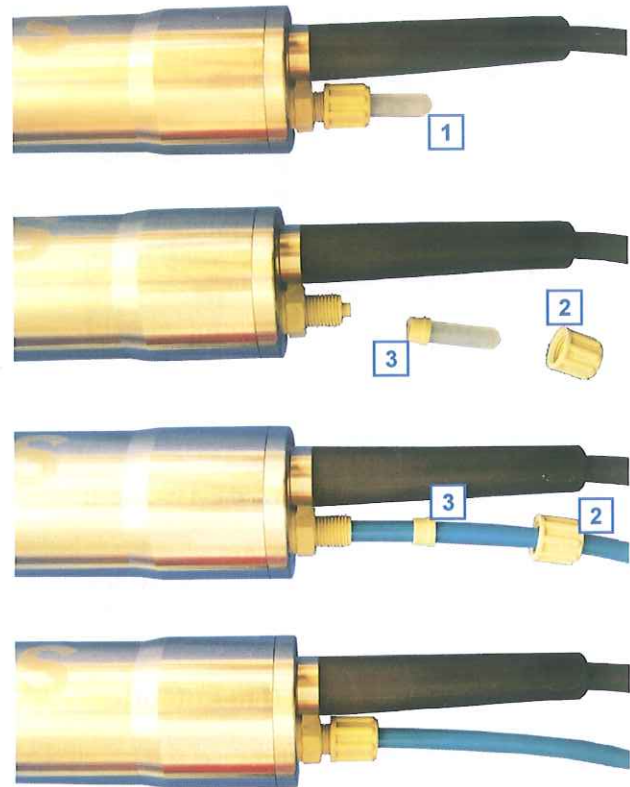

5 Initial Startup

Once the mounting and installation of the s::can spectrometer probe have been completed and checked (see chapter 4) the initial startup of the s::can monitoring system will require the following actions, in the order presented below:

- Connect the spectrometer probe to the controller used for operation (see section 5.1 and 5.2).
- Connect the cleaning devices to the proper terminal connections in the cable terminal compartment of the used controller (please refer to the manual of the controller).
- Establish power supply to the controller (please refer to the manual of the controller) and wait until the operation software has started up.
- Perform probe initialisation of the spectrometer probe. Refer to section 5.3.1 in case of using a con::lyte, refer to section 5.3.2 in case of using ana::lyte / ana::pro and refer to section 5.3.3 in case of using moni::tool.
- Perform parameterisation of the spectrometer probe. Refer to section 5.4.1 in case of using a con::lyte, refer to section 5.4.2 in case of using ana::lyte / ana::pro and refer to section 5.4.3 in case of using moni::tool.
- Configure the measurement and automatic cleaning settings. Refer to the technical specifications regarding cleaning settings. Additional information can be found in the respective manual of the controller.
- Check whether the cleaning system works properly.
- Connection and parameterisation of data transfer lines when desired (please refer to the manual of the controller).
- Check the readings obtained for plausibility after sufficient running-in time (at least 15 minutes).
- If necessary calibrate the readings of the spectrometer probe in stable water quality (see chapter 6).

5.1 Controller for Operation

For proper operation of the s::can spectrometer probe you will need one of the following controller and operating software respectively.

Controller	Type	Software
con::lyte	D-316, D-317, D-318, D-319	
con::cube	D-315	moni::tool V1.4, ana::xxx V5
con::stat	D-312, D-313, D-314	moni::tool V1.4, ana::xxx V5
con::nect + PC / notebook	B-23-bus	ana::xxx V5



s::can recommends to use the most actual version of the operating software on the controller.

5.2 Connection to the Controller

The s::can spectrometer probe will be delivered with a fixed cable including a plug that can be connected to the compatible socket provided on the controller. Ensure that the probe plug and the connector are dry and clean. Otherwise communication errors and / or device damage might occur. Damages caused by improper plug connection will not be covered by the warranty. Regarding definition of cable strands please refer to the technical specifications located at the end of this manual.

5.3 Probe Initialisation

5.3.1 Probe Initialisation using con::lyte

For operating of one or several probes using the con::lyte it is necessary to allocate an individual address to every probe. This can be done manually (supported by the software) as explained below. The corresponding address will be stored on the respective probe. For s::can probes and sensors, respectively the address can be set between 1 and 9. Be aware the procedures required will depend on the configuration of your s::can monitoring system.



The con::lyte should not be powered down or switched off during the initialisation process. In case of rebooting of the con::lyte during the initialisation process (e.g. caused by loss of power supply) the complete procedure of sensor initialisation has to be repeated.

- Establish the power supply to the con::lyte and select entry Settings / Parameterconfig / Install Probes in the main menu.
- Connect the spectrometer probe to the con::lyte (see section 5.2).
- Push the button Enter which starts the automatic search procedure for the connected probe. Once the probe is found, address 1 will be allocated. This procedure can last several seconds (see figures below).
- The successful completion of the initialisation will be displayed over a user message. If this message is displayed the initialisation procedure can be finished by pushing the button Esc.

```

Install probe 1
Connect only
probe 1
Continue with ENTER
Stop with ESC
  
```

```

Install probe 1
Searching for probe
  
```

```

Install probe 1
Probe search finished
G-Serie found
Continue with ENTER
Stop with ESC
  
```

A user message will also be displayed when no probe is detected. In this case please check the following before repeating the procedure for probe initialisation:

- Is only one probe connected to the con::lyte?
- Is the probe connected in properly?
- Are all wires of the con::lyte socket in the terminal compartment tight?

```

Install probe 1
Probe search finished
No probe found
Continue with ENTER
Stop with ESC
  
```

5.3.2 Probe Initialisation using ana::lyte / ana::pro

During start of ana::lyte the software will link up with the spectrometer probe automatically, when it has been connected properly. The required settings (configuration, references and current s::canpoint) will be loaded from the spectrometer probe and measuring in timer control mode will start automatically.

If ana-xxx was operated in timer control mode without spectrometer probe (Mode Offline) a user message after start provides the possibility to switch to Mode Online by pushing the button Online within 20 seconds and the search procedure for an spectrometer probe will start as explained above. After this time span or after pushing the button Continue ana::lyte will start the time control mode without connected spectrometer probe.

If ana::lyte cannot contact with any spectrometer probe, you will be informed via a dialogue window. The most common reason for failure to establish a connection is that there is no connection between probe and controller, or no power supply. In that case, please check all connections between spectrometer probe and controller as well as the power supply.

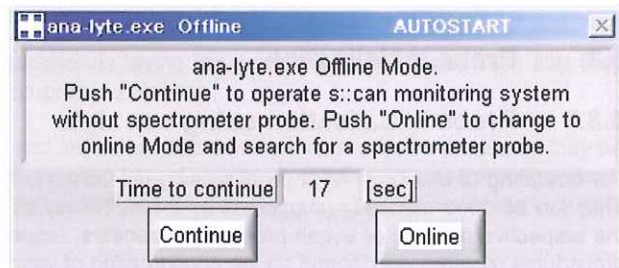
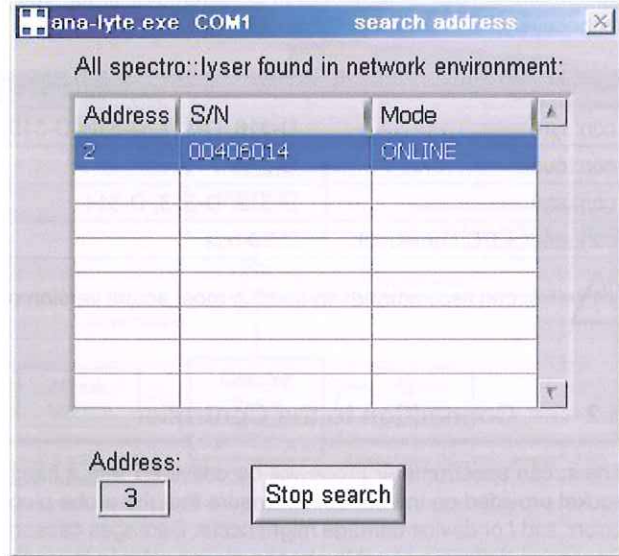

Once you have removed the problem, a mouse click on the *Search* button will start a new attempt to contact the spectrometer probe, and upon connection measurements will be started up in timer controlled mode automatically.

The default setting in the ana::lyte software is for the spectrometer probe to be connected to the COM1 port (first start-up) or the port to which it was connected during the last measurement performed. If the probe is connected to another COM-port, you have to check the manual of your PC to find out which port the spectrometer probe is connected to (COM 2, 3, 4 etc.). You can pick a different port from the pull-down menu *COM-port*. Click on the *Search* button for the automatic search for a probe and, if successful, for the start of measurements in timer control mode.

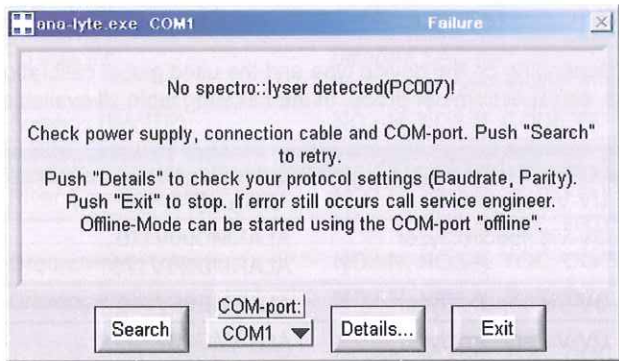

The button *Details...* enables you to set *Baudrate* and *Parity* for searching the probe. With the help of the button *Search...* the probe can be searched for automatically from address 0-9 on the selected COM-port using a several combinations of possible connection settings. If a probe is found under the selected COM-port while using the search function, the probe's settings can be set to the standard settings (Baud rate=38400, Parity=odd, Address=0). The button *Exit* closes ana::lyte.

Before changing the settings in *Details...* ensure that the correct COM-port has been selected.

5.3.3 Probe Initialisation using moni::tool

- Click the *Service* tab of the moni::tool screen and logon as *Administrator*.
- Click on an empty sensor icon (*Add new Sensor*) to initiate the automatic initialisation process.
- A new screen with progress bar as shown on the right side will pop up while moni::tool is searching for all connected probes and sensors. This procedure can be stopped using the button *Stop Search* or you can switch to the manual initialisation by pushing the button *Advanced Search*.
- As soon as moni::tool has searched all COM-ports and all addresses a screen lists up all connected probes and sensors. The *Status* column informs you if the *sensor is already installed* or if it a new one (*Found new sensor*).
- Click either on the blue plus sign (+) on the right side of the new sensor or on the button *Install All* to install the new sensor.
- moni::tool will finish initialisation of the new sensor (*Status: Installing sensor, please wait...*) and switch back to the *Service* tab showing the new sensor in the system overview.

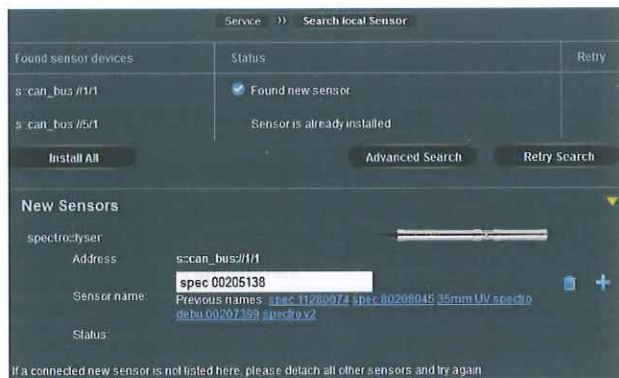

For manual / advanced initialisation the following steps have to be performed:

- Push the button *Advanced Search*.
- Select the correct connection (*Connection method*).
- Enter correct *COM-Port* and *Address*.
- Click the button *Start search*.

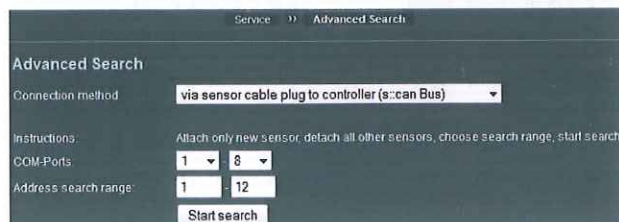

5.4 Probe Parameterisation

Depending on the device type and the used global calibration different combinations of parameter can be measured with the s::can spectrometer probe. In the following table all available global calibrations are shown.

Device Type	Global Calibration	Application	Parameter
UV-Vis spectro::lyser	AERATIONV150	Aeration (WWTP)	TS, NO3-N, CODf
UV-Vis spectro::lyser	ALARMD90V170 ALARMDNTV170	Drinking water + Alarm	Turbid., NO3-N, TOC, DOC (*)
UV-Vis spectro::lyser	ALARME95V150	Effluent (WWTP) + Alarm	TSS, NO3-N, COD, CODf
UV-Vis spectro::lyser	ALARMG90V160 ALARMGNTV160	Groundwater + Alarm	Turbid., NO3-N, TOC, DOC (*)
UV-Vis spectro::lyser	ALARMI90V150	Influent (WWTP) + Alarm	TSS, NO3-N, COD, CODf
UV-Vis spectro::lyser	ALARMPP90V150	Paper mill industry + Alarm	TSS, NO3-N, COD, CODf
UV-Vis spectro::lyser	ALARMR90V160 ALARMRNTV160	River & surface w. + Alarm	Turbid., NO3-N, TOC, DOC (*)
UV-Vis spectro::lyser	BREWERY0V150	Brewery industry	TSS, COD
UV-Vis spectro::lyser	DRINK001V170 DRINK0NTV170	Drinking water	Turbid., NO3-N, TOC, DOC (*)
UV-Vis spectro::lyser	DRICLD01V170 DRICLDNTV170	Drinking water + chlorine demand	Turbid., NO3-N, TOC, DOC, CLD (*)
UV-Vis spectro::lyser	DRINK_O3V170 DRI_O3NTV170	Drinking water + ozone	Turbid., NO3-N, TOC, DOC, Ozone (*)
UV-Vis spectro::lyser	DRINKCOLV170 DRICOLNTV170	Drinking water + color (Hazen)	Turbid., NO3-N, TOC, DOC, ColorTru, ColorApp (*)
UV-Vis spectro::lyser	EFFLUENTV150	Effluent (WWTP)	TSS, NO3-N, COD, CODf
UV-Vis spectro::lyser	EFFLUBODV150	Effluent (WWTP) + BOD	TSS, NO3-N, COD, BOD
UV-Vis spectro::lyser	EFFLUCOLV150	Effluent (WWTP) + color	TSS, NO3-N, COD, CODf, ColorTru, ColorApp
UV-Vis spectro::lyser	GROUND00V150 GROUNDNTV160	Groundwater	Turbid., NO3-N, TOC, DOC (*)
UV-Vis spectro::lyser	GROUNH2SV150 GROH2SNTV160	Groundwater + HS ⁻	Turbid., NO3-N, TOC, DOC, pH, HS ⁻ , H2S (*)
UV-Vis spectro::lyser	GROUNCOLV150 GROCOLNTV160	Groundwater + color	Turbid., NO3-N, TOC, DOC, ColorTru, ColorApp (*)
UV-Vis spectro::lyser	INFLUBODV150	Influent (WWTP) + BOD	TSS, NO3-N, COD, BOD
UV-Vis spectro::lyser	INFLUH2SV160	Influent (WWTP) + HS ⁻	TSS, NO3-N, COD, CODf, pH, HS ⁻ , H2S
UV-Vis spectro::lyser	INFLUENTV160	Influent (WWTP)	TSS, NO3-N, COD, CODf
UV-Vis spectro::lyser	PAPEREFFV150	Paper mill industry effluent	TSS, NO3-N, COD, CODf
UV-Vis spectro::lyser	PAPERINOV150	Paper mill industry influent	TSS, COD, CODf
UV-Vis spectro::lyser	RIVER001V150 RIVER0NTV160	River & surface water	Turbid., NO3-N, TOC, DOC (*)
UV-Vis spectro::lyser	RIVERBODV160	River & surface water	TSS, NO3-N, TOC, BOD, CODf
UV-Vis spectro::lyser	RIVERCOLV150 RIVCOLNTV160	River & surface w. + color	Turbid., NO3-N, TOC, DOC, ColorTru, ColorApp (*)
UV-Vis spectro::lyser	SA_MILCHV150	Dairy industry	TSS, NO3-N, COD

(*) measures the same parameters as mentioned above but unit of Turbid. is [NTU] instead of [FTU]

Device Type	Global Calibration	Application	Parameter
UV-Vis spectro::lyser	TEST0000V160	no specific	different SAC can be configured individually
UV spectro::lyser	UV_AER00V16T	Aeration (WWTP)	NO2-N, NO3-N, CODf, TS
UV spectro::lyser	UV_ALD90V170	Drinking water + Alarm	NO2-N, NO3-N, TOC, DOC
UV spectro::lyser	UV_ALR90V150 UV_ALRNTV160	River & surface w. + Alarm	NO2-N, NO3-N, TOC, FTU NO2-N, NO3-N, TOC, NTU
UV spectro::lyser	UV_ALGNTV160	Groundwater + Alarm	NO2-N, NO3-N, TOC, DOC
UV spectro::lyser	UV_DRINKV170 UV_DRINTV170	Drinking water	NO2-N, NO3-N, TOC, DOC, FTU NO2-N, NO3-N, TOC, DOC, NTU
UV spectro::lyser	UV_EFFLUV150	Effluent (WWTP)	NO2-N, NO3-N, COD, TSS
UV spectro::lyser	UV_GROUNV150 UV_GRNTUV160	Groundwater	NO2-N, NO3-N, TOC, FTU NO2-N, NO3-N, TOC, NTU
UV spectro::lyser	UV_RIVERV150 UV_RIVNTV160	River & surface water	NO2-N, NO3-N, TOC, FTU NO2-N, NO3-N, TOC, NTU
UV spectro::lyser	UV_TEST1V15T	no specific	different SAC can be configured individually
carbo::lyser II	GC2 a pppp V nn T a = Application pppp = Parameter nn = No. of version	a = aeration d = drinking water e = effluent (WWTP) i = influent (WWTP) r = river & surface water	54T = FTU, SAC254total 54TN = NTU, SAC254total 54F = FTU, SAC254filt. 54FN = NTU, SAC254filt. TOC = FTU, TOC TOCN = NTU, TOC DOC = FTU, DOC DOCN = NTU, DOC COD0 = TSS, CODtotal CODF = TSS, CODfilt. BOD = TSS, BOD
carbo::lyser III	GC3 a pppp V nn T a = Application pppp = Parameter nn = No. of version	d = drinking water e = effluent (WWTP) i = influent (WWTP) r = river & surface water	2540 = FTU, SAC254total, SAC254filt. 254N = NTU, SAC254total, SAC254filt. TOC0 = FTU, TOC, DOC TOCN = NTU, TOC, DOC COD0 = TSS, COD, CODf BOD0 = TSS, COD, BOD
color::lyser II	GT2 a pppp V nn T a = Application pppp = Parameter nn = No. of version	d = drinking water e = effluent (WWTP) r = river & surface water	400T = FTU or TSS, Hazen-total 400C = FTU or TSS, Hazen-filt. 40TN = NTU or TSS, Hazen-total 40CN = NTU or TSS, Hazen-filt.

(*) measures the same parameters as mentioned above but unit of Turbid. is [NTU] instead of [FTU]

Device Type	Global Calibration	Application	Parameter
multi::lyser II	GM2 a pppp V nn T a = Application pppp = Parameter nn = No. of version	d = drinking water e = effluent (WWTP) i = influent (WWTP) r = river & surface water	54T = NO3-N, SAC254total 54F = NO3-N, SAC254filt. TOC = NO3-N, TOC DOC = NO3-N, DOC COD = NO3-N, CODtotal COF = NO3-N, CODfilt. BOD = NO3-N, BOD
multi::lyser III	GM3 a pppp V nn T a = Application pppp = Parameter nn = No. of version	d = drinking water e = effluent (WWTP) i = influent (WWTP) r = river & surface water	54T = FTU, NO3-N, SAC254total 54TN = NTU, NO3-N, SAC254total 54F = FTU, NO3-N, SAC254filt. 54FN = NTU, NO3-N, SAC254filt. TOC = FTU, NO3-N, TOC TOCN = NTU, NO3-N, TOC DOC = FTU, NO3-N, DOC DOCN = NTU, NO3-N, DOC COD = TSS, NO3-N, CODtotal COF = TSS, NO3-N, CODfilt. BOD = TSS, NO3-N, BOD
nitro::lyser	GN2 a 000p V nn T a = Application p = Parameter nn = No. of version	a = aeration d = drinking water e = effluent (WWTP) i = influent (WWTP) r = river & surface water	0, 1 = FTU, NO3-N N = NTU, NO3-N
uv::lyser	GU2 a pppp V nn T a = Application pppp = Parameter nn = No. of version	a = aeration d = drinking water e = effluent (WWTP) i = influent (WWTP) r = river & surface water	254T = FTU or TSS, SAC254total 254C = FTU or TSS, SAC254filt. 54TN = NTU or TSS, SAC254total 54CN = NTU or TSS, SAC254filt.

(*) measures the same parameters as mentioned above but unit of Turbid. is [NTU] instead of [FTU]

5.4.1 Probe Parameterisation using con::lyte

After successful probe initialisation (see section 5.3.1) the measuring parameters of the spectrometer probe will be displayed on the display of the con::lyte automatically. If needed the measuring parameters can be configured individually using the menu item Settings / Parameterconfig / Parameter n.

The name of the Probe or sensor used as a source of the parameter is displayed in the upper line (e.g. G-Serie). If several probes or sensors are installed the instrument from which a parameter needs to be displayed can be selected here. Under the entry Probe the Address that has been allocated to that probe is displayed as an additional information.

Parameter 1	
Probe:	G-Serie
Address:	1
Index:	0
Unit:	mg/l
Decimal places:	auto

The Index specifies the place of the corresponding parameter in the actual used global calibration of the spectrometer probe. The Unit of the selected parameter is displayed in the line below (see section 5.4). The item Decimal places enables setting of the number of displayed decimal places (between 0 and 4). With the default setting auto the number of decimal places will be automatically set by the probe.

For selecting a new global calibration you have to select the item Calibration / G-Serie / Global calibration in the con::lyte main menu. Please refer to the manual con::lyte for further details.

5.4.2 Probe Parameterisation using ana::lyte / ana::pro

After successful probe initialisation (see section 5.3.2) the parameter of the actual used global calibration will be displayed on the Value display of ana-xxx.

The following actions of parameterisation can be performed with ana::lyte / anapro:

- Removing a parameter from the display.
- Adding a new non spectral parameter (e.g. temperature).
- Adding a new spectral parameter defined by the customer (e.g. SAC).
- Changing the displayed spectral parameter by creating a new s::canpoint and selecting another global calibration available on the spectrometer probe (see section 5.4).

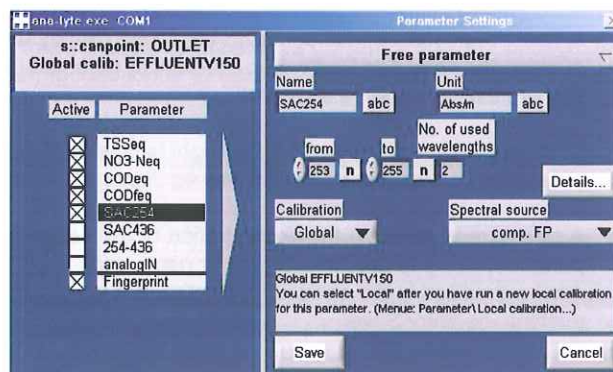

For removing or adding parameters you have to select the menu item Parameter / Settings in the main menu of ana::pro or in the advanced mode of ana::lyte. Please refer to the manual ana::lyte / ana::pro for further details.

For selecting a new global calibration you have to select the menu item Parameter / Global Calibration / Change s::canpoint... in the main menu of ana::pro or in the advanced mode of ana::lyte. Please refer to the manual ana::lyte / ana::pro for further details.

 After removing one or several of the spectral parameters predefined in the global calibration, they can be reactivated only by creating a new s::canpoint and selecting this global calibration once again.

5.4.3 Probe Parameterisation using moni::tool

After successful probe initialisation (see section 5.3.3) all parameters of the actual used global calibration will be installed and automatically displayed on the *Values* screen of moni::tool. If you want to configure the measuring parameters individually this can be done using the menu item *Menu / Settings / Parameter*.

After selecting that menu item a list of all installed parameters is displayed. After selecting one or several parameters by clicking on them the following activities can be performed:

- Moving the selected parameter to a higher position in the *Values* display by pushing the entry *Up*.
- Moving the selected parameter to a lower position in the *Values* display by pushing the entry *Down*.
- Deleting the selected parameter from *Values* display by pushing the entry *Remove Parameter*. This action has to be confirmed in a new screen by pushing the button *Delete all*.
- A new parameter can be added to the *Value* display by pushing the entry *Add Parameter*. A table of all parameters that are available will be displayed.
- Click on the blue plus sign (+) on the right hand side of the parameter you want to add to the *Values* display.
- A new screen showing the configuration of the selected parameter will pop up. The *Parameter name* and the *Unit* can be modified in the entry field. Confirm this screen by pushing the entry *Save*.

The screen to read and / or modify parameter settings is also available when clicking on the blue cog wheel (*Edit*) on the right side of the parameter list.

Clicking on the other signs located on the right side of the parameter enables the modification of vali::tool (*::tool*) and ana::alarm (*Alarm*) settings. Please refer to the manual moni::tool regarding detailed information.

Parameter name	Unit	Sensor name	Edit	::tool	Alarm
Turbidity	FTUeq	1.0 w spec 80208045	⚙️	✓	⚙️
NO3-Heq	mg/l	1.0 w spec 80208045	⚙️	✓	⚙️
TOCeq	mg/l	1.0 w spec 80208045	⚙️	✓	⚙️
DOCEq	mg/l	1.0 w spec 80208045	⚙️	✓	⚙️

Delete selected objects and dependencies

Objects that will be deleted:

- [Parameter] DOCEq

You are about to delete the selected objects and objects that are dependent on it. Are you sure you want to continue?

Cancel

Delete all

Sensor name	Address	Parameter name	Add
1.0 w spec 80208045	s::can_bus //5/3/4	DOCEq	+

Menu >> Settings >> Parameter >> Add Parameter >> Edit parameter

Cancel Save

Install parameter DOCEq

Sensor name: 1.0 w spec 80208045
 Address: s::can_bus //5/3/4
 Internal parameter name: DOCEq
 Parameter name (Display): Dissolved Carbon
 Internal unit: mg/l
 Unit (Display): mg per liter
 Resolution: 2
 Upper limit: 15.0
 Lower limit: 0.0
 Installed by:

Dissolved Carbon

Raw value: 1.97
1.97
 mg per liter
 08-10-2011 11:24

✓ • C

1.0.w spec 80208045

6 Calibration

At each measurement the s::can spectrometer probe detects the absorbance at different wave lengths caused by the measured medium. This so called fingerprint is used to calculate different parameters (e.g. NO₃-N, COD) based on the global calibration the spectrometer probe is equipped with. Global calibrations are standard spectral algorithms available for specific conditions of typical applications (e.g. municipal waste water, river water, drinking water) in such a way, that the spectrometer probe can be used immediately after delivery.

With a local calibration the respective parameters can be adapted to the actual concentrations if required. A local calibration can be performed directly on site without demounting the spectrometer probe or using standard solutions. Once the spectrometer probe is local calibrated to the specific medium there is no need to recalibrate the spectrometer probe any more. Only the measuring windows have to be kept clean.

Data base for each local calibration are results of conventional laboratory analysis on one hand and the absorbance spectra measured with the spectrometer probe on the other hand. Because comparison analyses are made in the laboratory, it is necessary to take random samples. The measurement of the fingerprints takes place directly in the process (on-line and in-situ). Caused by this fact not only the deviation of the different methods influences the quality of the calibration but also the total sampling failure (homogeneity of medium, biochemical reactions from sampling to analysing).

Samples have to be chosen in such a way, that they enable you to cover the whole measuring range with only a few samples. Therefore, s::can recommends to take one sample at low and one at high concentration. Under normal circumstances a two-point calibration based on these samples will be satisfactory.

When using calibration standards you have to keep in mind that these standards will always present a different background matrix compared to the real measuring medium. Therefore s::can recommends to use such calibration standards only for checking of sensor integrity and linearity (see section 8.3 and 8.4).

- Before performing any kind of sample measurement the cleanliness of the measuring windows should be ensured (please refer to section 9.1).
- Before performing the sample measurement in-situ, the probe has to be submersed into the medium (at least 15 min.).
- When performing the sample measurement with the multifunctional slide, spill the slide several times with the calibration medium (sample) before measuring the sample. Perform the sample measurement immediately after filling the slide, to avoid any effluence due to sedimentation.
- A sample measurement has to be triggered at the same time the sample for laboratory analysis is taken.
- The result of the laboratory analysis can also be entered later.
- The calibration will not be executed and used till the menu item *Calibrate!* is selected.
- When performing a parameter calibration the result will be checked for plausibility. In case of faulty calibration an error message will be displayed to the operator. Please refer to section 10.2 regarding possible error messages and notes for removal.
- On the spectrometer probe itself two sample readings and two corresponding laboratory results can be stored for each parameter. Furthermore the coefficients of the local calibration (offset and slope) are stored onto the probe.
- In case of a spectro::lyser the complete fingerprint of the sample measurement is stored in the calibration database. Therefore this sample can be used for local calibration of several parameters calculated from this fingerprint. This calibration database is stored on the controller (moni::tool or ana::xxx) and not on the probe itself.

6.1 Types of Calibration

Depending on the type of the spectrometer probe (G-Serie or spectro::lyser) and the used controller for operation different types of calibration can be performed.

Operating device	Offset (1-point calibration)	Linear (2-point calibration)	Linear (Multi-point calibration)
con::lyte	all types	all types	not supported
ana::lyte	all types	all types	only spectro::lyser
ana::pro	all types	all types	only spectro::lyser
moni::tool	all types	all types	only spectro::lyser

6.1.1 Offset Calibration with 1 Sample

- For offset calibration one sample measurement and one laboratory result is needed.
- Offset calibration shall be used to adapt the global calibration to the actual medium when needed.
- When performing an offset calibration with the slope of the global calibration will be used.

Select calibration type

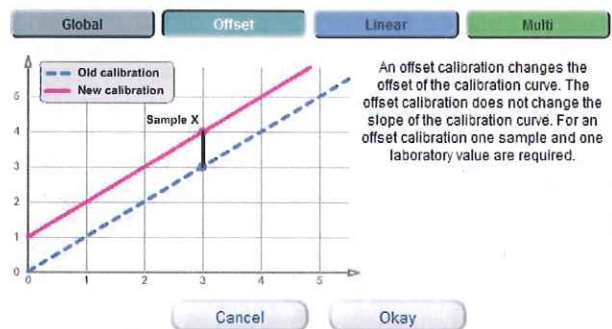

6.1.2 Linear Calibration with 2 Samples

- For linear calibration two sample measurements and two laboratory results are needed.
- When performing a linear calibration both, the offset and the slope of the global calibration will be changed.
- After linear calibration a new offset calibration can only be performed by deleting the laboratory result of the second sample.
- An offset calibration performed after a linear calibration will again use the slope of the global calibration.

Select calibration type

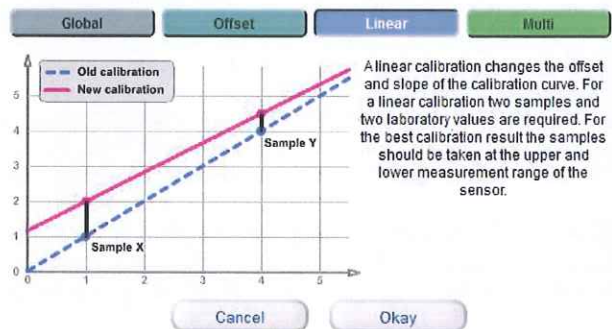

6.1.3 Linear Calibration with several Samples

- When performing a linear calibration with the spectro::lyser even more samples can be used.
- The offset and the slope are calculated in that way to obtain the smallest possible deviation.
- The samples will be stored on the controller, only the calculated offset and slope will be stored onto the probe.

Select calibration type

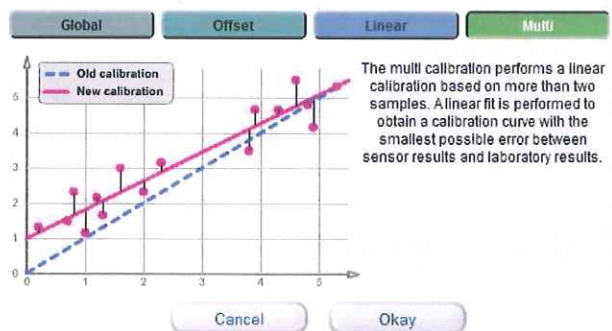

6.1.4 Non Linear Calibration

- For non linear calibration at least three samples and three laboratory results are needed.
- Non linear calibration can only be performed with spectro::lyser and ana::pro.
- s::can recommends to perform non linear calibration only in exceptional cases with validated laboratory results.

6.2 Performing a Calibration

6.2.1 Calibration using con::lyte

Using the con::lyte only a local calibration based on the two samples being stored onto the probe is possible, independent whether the probe is a G-Serie or a spectro::lyser.

The Calibration entry in the con::lyte main menu leads you into the menu that enables the calibration of the spectrometer probe. When Calibration is selected a password must be entered (password = 1) before the calibration can be started. The next step is selection of the parameter to be calibrated (e.g. TSS) in the selection field Param Calibration.

Param Calibration	
Local cal.:	TSS
Local cal.:	?????

Now the menu for local calibration will appear as displayed on the right hand side.

The entry Calib. shows global as long as global calibration is still active. When selecting this entry you can switch to local. Now the entry Type shows the type of calibration (linear).

Local cal.	TSS
Calib.:	global
Type:	-----
Sample 1:	
Lab 1:	

The display shows the samples actually stored onto the probe (Sample 1 and Sample 2) as well as the laboratory results (Lab 1 and Lab 2). In case no reading is stored the display will show dashes (-----) instead of a numerical value. A new sample measurement can be triggered by selecting the entry (Sample 1 or Sample 2) and pushing the button Enter. The results of the laboratory analysis can be entered on the corresponding entry Lab.

Local cal.	TSS
Calib.:	local
Type:	linear
Sample 1:	
Lab 1:	
Sample 2:	
Lab 2:	
Calibrate!	

As long as only a value for Lab 1 is entered the spectrometer probe will perform a single point calibration. A lab result can be removed by selecting the entry Lab and pushing the Function button.

When the entry Calibrate! is confirmed by pushing Enter, a calibration is performed. Successful calibration is shown in a user message (o.k.). If the calibration was not successful (user message Error) the calibration used up to now will be used further on.

To switch back to the global calibration (factory default) the calibration type global has to be selected and the entry Calib and has to be confirmed by pushing Calibrate!

6.2.2 Calibration G-Serie using ana::lyte / ana::pro

Via the menu entry *Local Calibration*, located on top of the measuring display, the parameters of all connected probes can be locally calibrated. After selecting this menu entry, a user window appears which shows all parameters. Besides the parameter name (*Name*) also the unit of the parameter (*Unit*), the probe used to measure this parameter (*Device*), the *COM port* to which the probe is connected and the address of the probe (*Address*) are displayed. The parameter selected for calibration has a blue background and can be confirmed with the *Ok* button.

Furthermore the local calibration can also be started in advanced mode of ana::lyte and ana::pro, respectively using the menu entry *Parameter / Settings*.

Firstly, in the dialogue window *select*, the parameter to be calibrated is selected via a selection list. After confirming of the selection with the *Ok* button, a dialogue window appears where the local calibration can be performed. In this window, the two measured values (*Probe result*) are displayed on the left hand side, and the two laboratory values (*Laboratory result*) on the right hand side. In case no values have been measured or entered respectively, the indication *NaN* will be visible.

When the button *Sample 1* is pushed, a measurement by the spectrometer probe is started. At the same time, a grab sample should be taken for later analysis in the laboratory. After the measurement is completed, the parameter reading is displayed together with the date and time of the measurement (see figure on the right). The laboratory result can later be entered using the numerical keypad that appears after clicking on the *n* button. When the measured value and the reference value have been entered, the button *Offset* will appear. Clicking on this button will start a single-point calibration. A user message, which has to be confirmed with *Ok* displays the calculated offset (*intercept*). The slope is equal to 1.0 (*slope*) which means the slope of the global calibration will be unchanged.

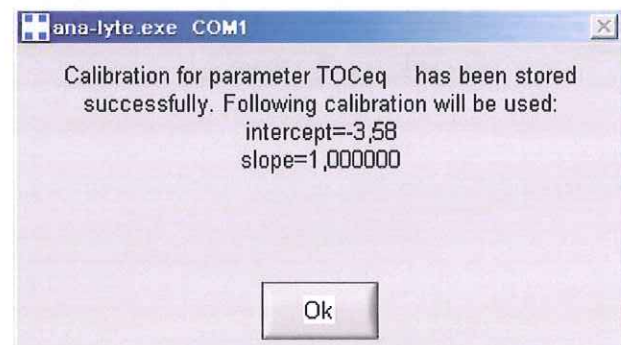
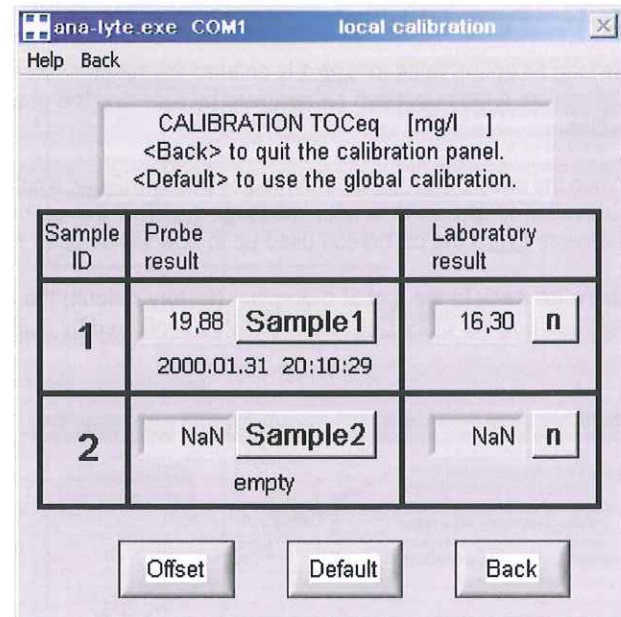
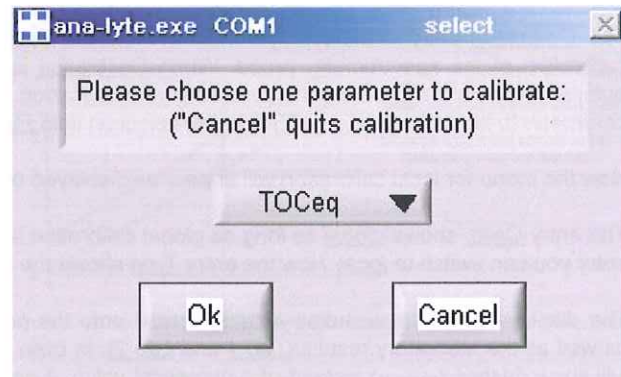
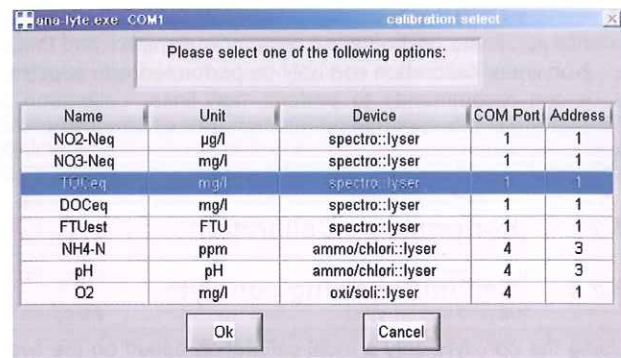

When sample ID 2 (*Sample 2*) also contains a measured value and reference value, the button *2-Point* will appear, which allows a linear calibration. After a successful calibration, a text box will display the offset (*intercept*) and the *slope* of the calibration line.

When a reference value that has been entered must be deleted again, for example when a single point calibration is to be performed, this can be done by clicking on the *n*-button next to the value and pressing *=* until the value has been removed.

Pushing the button *Default* in the dialogue window of the local calibration will again activate the global calibration after confirming the query with *Yes*.

The button *Back* in the local calibration screen closes the calibration screen and reactivates the measurement process with the modified calibration, as the case may be.

 The readings displayed beside *Sample1* and *Sample2* are always the results based on the global calibration.

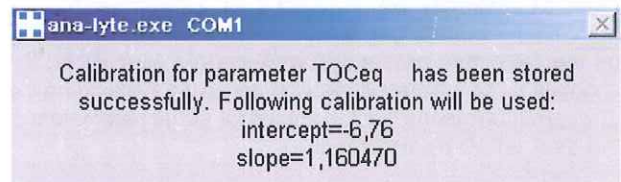
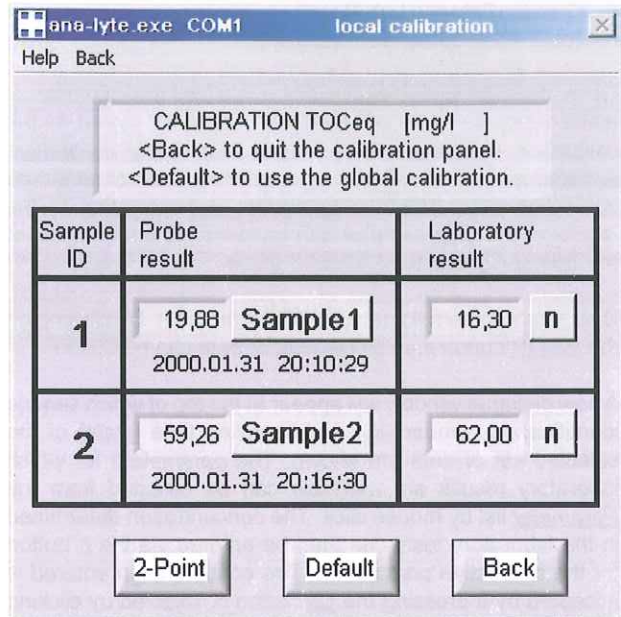

6.2.3 Calibration spectro::lyser using ana::lyte / ana::pro

■ Step 1: Sampling (FP-Sample)

The actual reading, executed at the time of taking the sample has to be stored into the calibration database. Therefore a button *FP-Sample* is located in the left-hand part of the measuring screen (irrespective of the view displayed – *Values*, *Time Series* or *Fingerprint*). By pushing this button the fingerprint of the latest measurement (Time of measurement can be checked in display *Last value*) will be stored as comparison measurement in the calibration database (kalib.db). A message will subsequently give you the number of the sample (*Sample ID*) and the time of sampling (*Date of Sample*). Careful documentation of these data is indispensable for successful local calibration at a later point in time!

 Since ana::lyte version 5.3g no measurement of the spectrometer probe will be executed when the button *Sample* is pushed. Instead the result of the last measurement performed will be stored into the calibration database (kalib.db).

s::can recommends to check the plausibility of the actual reading (stability of measurement, shape of fingerprints) before pushing the *FP-Sample* button. If necessary the measuring interval can be reduced for short time. In operation mode *Manual* a single measurement has to be executed before pushing the *FP-Sample* button. If no reading exists the error message (*IN103*) will be displayed.

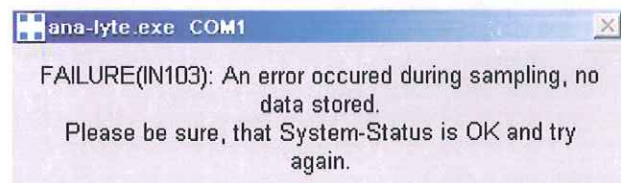
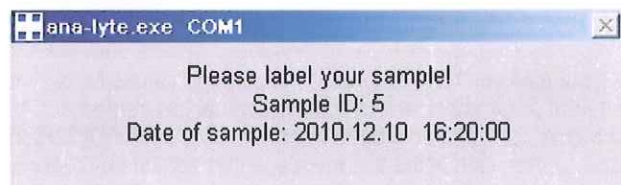

■ Step 2: Entering Lab Result (calibration database – kalib.db)

Once the laboratory results are available, the outcome of these analyses can be linked with the data stored in the calibration database via the menu item *Local calibration*. A dialogue window will pop up and show a list of all stored calibration data. The measurements corresponding to the results of the grab samples can be identified on the basis of the *Sample ID* and the *Date of Sample*.

Data sets can be selected by clicking on them. By clicking on the *Edit ID* button the selected set of data can be edited.

A new dialogue window will appear at the top of which sample identification number (*ID*) and sampling time (*Date*) of the selected set of data are shown. The parameters for which laboratory results are available can be selected from the *Parameter* list by mouse click. The concentration determined in the laboratory tests can then be entered via the *n* button for the respective parameters. The concentration entered is accepted by a pressing the *Ok* button or rejected by clicking on *Cancel*. *Clear* will return you to *NaN* (no value entered). Once all laboratory concentrations for a given set of data have been entered, the window can be closed by clicking on the *Ok* button on the bottom left. Only then will all the changes in the calibration data set be saved! Clicking on the *Cancel* button means that the entries for all the parameters of this data set will be discarded!

Clicking on the *Delete ID* button, which has to be confirmed by a mouse click on the *Yes* button, will result in the permanent deletion of the selected set of data (*Sample ID*) from the calibration data base.

The *Ok* button on the bottom left in the calibration database screen will prompt a message offering you to carry out a local calibration process; it has to be confirmed by clicking on *Yes*. Clicking on *No* will lead to the termination of the calibration process and return to timer-controlled measuring mode. The *Cancel* button on the bottom right closes the *local calibration database* dialogue window and leads back to the timer controlled measuring mode.

■ Step 3: Performing the Local Calibration

As soon as you have entered the laboratory values for one or several parameters, a local calibration can be carried out. In the *local calibration* dialogue window a click on the *Ok* button and confirmation of the text message that appears by clicking on *Yes* starts the local calibration sequence. Firstly, in the dialogue window *select*, the parameter to be calibrated is selected via a selection list.

S-ID	Date of Sample	Parameter							
		current name	NO2-Neq	NO3-Neq	TOCeQ	DOCeQ	FTUest	NH-N	pH
1	2010.11.25 12:54	NaN	NaN	NaN	NaN	NaN	NaN	NaN	NaN
2	2010.11.25 12:56	4,00	NaN	NaN	NaN	NaN	NaN	NaN	NaN
3	2010.11.25 12:56	3,00	NaN	NaN	NaN	NaN	NaN	NaN	NaN
4	2010.12.10 16:15	NaN	NaN	NaN	NaN	NaN	NaN	NaN	NaN
5	2010.12.10 16:20	NaN	NaN	NaN	NaN	NaN	NaN	NaN	NaN
6	2010.12.10 16:26	NaN	NaN	NaN	NaN	NaN	NaN	NaN	NaN

ID: 1 Date: 2010.11.25 12:54

Parameter:

NO2-Neq	8,0
NO3-Neq	NaN
TOCeQ	NaN
DOCeQ	NaN
FTUest	NaN
SAC254	NaN
SAC280	NaN
analogIN	NaN

16,50 n Clear Ok Cancel

ID: 1 Date: 2010.11.25 12:54

Parameter:

NO2-Neq	8,0
NO3-Neq	NaN
TOCeQ	16,5
DOCeQ	NaN
FTUest	NaN
SAC254	NaN
SAC280	NaN
analogIN	NaN

Ok Cancel

Do you want to calculate a new local calibration?

Yes No

The calibration can then be started by clicking on either the *Auto* or *Manual* button. In the case of *Auto* the local calibration will be performed automatically. In the case of *Manual* you will be able to control certain stages of the calibration stages (e.g. elimination of outliers) yourself. After finishing a calibration, you will return to this dialogue window and can repeat the calibration, calibrate a different parameter or quit calibrating by clicking on *Back* or *Cancel*, respectively, so as to continue again in the measuring mode.

When *Local calibration* is activated, the automatic measuring process is interrupted!

If local calibration is not possible in a certain case (e.g. not enough lab results) or if the result is not plausible (e.g. negative calibration line), the user will receive related messages in automatic and manual calibration mode.

■ Step 3A: Performing the Local Calibration automatically (Auto)

When *Auto* is selected in the dialogue window *select* the local calibration will be performed automatically by ana::xxx. The result of calibration is displayed on the calibration screen, which is presented in the background. All calibration results will be stored in the folder "Calibration name" located in the subfolder *C:\s-can\Settings\My Calib*. When the local calibration of a parameter is performed for the first time, the calibration name is automatically set to "ORIGINAL". The next time a local calibration is performed for the same parameter, a dialogue window will appear and tell you a new name can be allocated or the old calibration can be overwritten.

By clicking on *Yes* the existing local calibration stored under this name ("ORIGINAL") will be overwritten. By selecting *new...* a new dialogue window opens where the calibration name (e.g. KAL_1012) for a new folder can be entered.

Once you have created two or more different calibration folders on your controller a dialogue window for storing the calibration result appears. You can either select an existing calibration name or create a new one by clicking on *new...* in the selection box and entering the name in the next dialogue window.

The local calibration results can be saved under a single calibration name for different parameters but only once for each.

Via the menu item *Parameter/Settings* the desired calibration (present global or one of the stored local) can be selected for each parameter.

Via the menu item *Help/Show Context Help* the information on the parameter type, global or local calibration, can be requested in the measuring screen as soon as the mouse pointer is moved over the parameter.

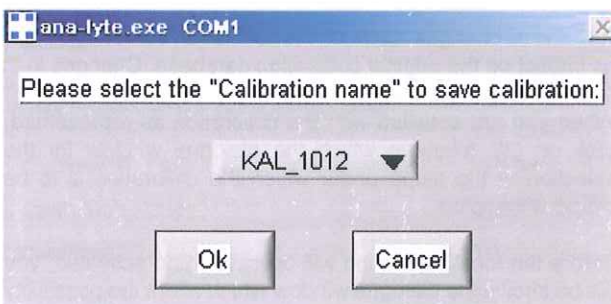
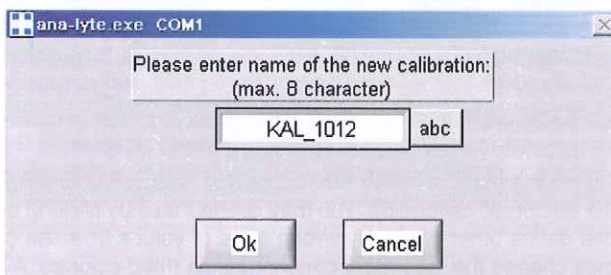
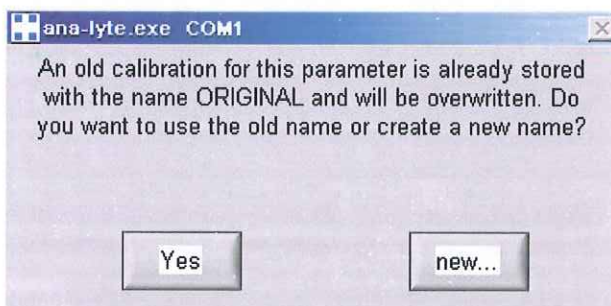
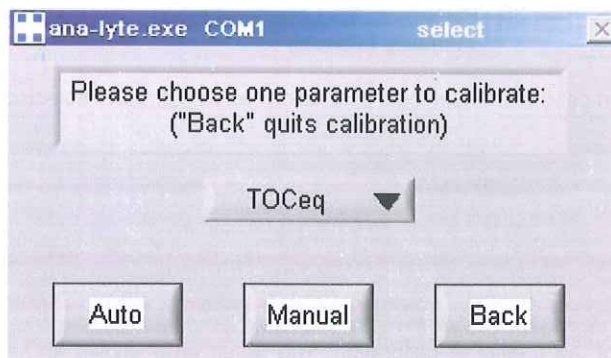

■ Step 3B: Performing the Local Calibration manually (Manual)

In case of manual local calibration, when *Manual* is selected in the dialogue window *Select* (see step 3 above), you will be able to control part of the calibration process manually. After selecting *Manual* the screen *Local calibration* will appear.

In the right-hand half of this screen the calibration function (red), which describes the relation between the readings of the probe (x-axis) and the results from laboratory analyses (y-axis), is displayed so that you can get a visual impression of the quality of calibration. The *Mean error* shown above the diagram states the mean absolute deviation between laboratory results and calibrated readings in %. This error is measured against the measuring range of the laboratory results ($\text{laboratory}_{\text{MAX}} - \text{laboratory}_{\text{MIN}}$).

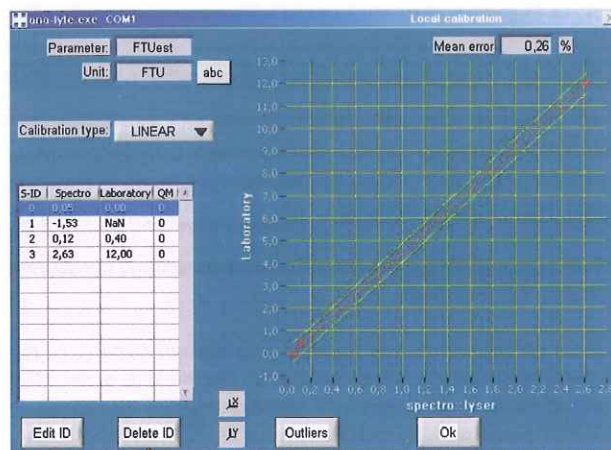

The left-hand side of the screen shows the following text boxes and selection lists:

- **Parameter:** Parameter that is being calibrated locally.
- **Unit:** Unit for the respective parameter (can be entered or modified via the *abc* button).
- **Calibration type:** Type of calibration (*linear* calibration by default).

The table located in the lower half of the left hand side of the screen consists of four columns:

- **S-ID:** shows the sample number (Sample ID).
- **Spectro:** shows the parameter reading calculated from the fingerprint using the global calibration.
- **Laboratory:** shows the laboratory results entered in the calibration database.
- **QM:** shows the s::can quality mark of the parameter.

If no comparative concentrations for a Sample ID are entered in the calibration database, or if the s::can reading is outside the measuring range, this table will show the entry *NaN* – the Sample ID concerned will not be taken into consideration in the local calibration.

In addition a zero point with Sample ID 0 is automatically included in this table. This makes it possible to perform linear calibration if only one sample is available. This „fictitious calibration point“ can be deleted when multiple pairs of values are available.

During the manual calibration, you will receive information about the outliers which would have been deleted automatically in the automatic calibration. You may delete these by clicking on the *Delete ID* button. If you are not satisfied with the result, you can delete other obviously wrong pairs of values from the calibration table. Moreover, by clicking on the *Edit ID* button, you may change the laboratory concentrations (third column). A bar on the right of the table allows for scrolling and access to all pairs of values. The calibration is recalculated after each change.

Any and all changes made on the calibration screen (*Edit ID* or *Delete ID*) are only effective in the ongoing calibration and have no impact on the original calibration database. Changes in the calibration database are described in step 2 above.

When you are satisfied with the calibration as represented, click on *Ok*, following which the dialogue window for the selection of the name under which the calibration is to be stored will pop up.

Before the local calibration will be saved and activated, you will be shown the dialogue window which offers the possibility to accept the new calibration by clicking on *Yes* or to return to the dialogue window *Select* without saving the new calibration by clicking on *No*. In the latter case, the calibration that was active previously (either global or local calibration) will remain active without change.

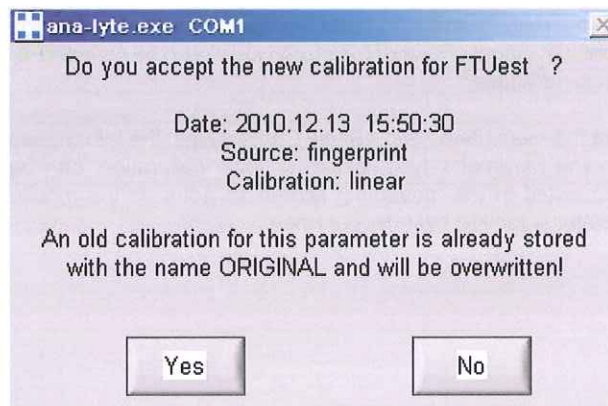

6.2.4 Calibration using moni::tool

The calibration procedure will be started by the following steps:

- Click the Service tab of the moni::tool screen and logon as Administrator.
- Click the icon of the spectrometer probe you want to calibrate in the shown overview of the monitoring system.
- Click the icon Calibrate sensor in the next screen.
- Now the screen will show a list of all parameters being measured by this probe. Clicking on the blue triangles will open more information about actual used calibration for this parameter. Furthermore a click on the History icon rightmost opens a logbook showing all performed calibration procedures up to now.
- Open the calibration screen by clicking on the Calibrate icon on the right hand side of the parameter you want to calibrate.

Parameter name	Last calibration	Calibrate	History
Turbidity	Multi		
NO3-Neg	Offset Coefficient 0 - Offset 0.5020 Coefficient 1 - Slope 1.0000		
TOCeq	Global		
DOCe	Global		

1 Select the Calibration type you want to perform (see section 6.1).

2 The current readings of the parameter will be displayed numerically and graphically.

3 A new measurement of the spectrometer probe will be performed whenever you push the button Trigger measurement.

4 Push the Sample icon to perform a new measurement and store the reading onto the probe. Please note that the displayed value is the Raw value, based on the global calibration.

5 Enter the result of the laboratory analysis into the entry field Lab and push the button Save to store this value onto the probe.

7 Push the button Perform Calibration to start the calibration procedure based on the selection (Calibration type) you have done.

8 After the calibration procedure is finished a user message will inform you, if the local calibration of parameter was successful. In case of an error the reason will be displayed to the user in red letters (e.g. Please enter at least lab values for 2 samples).

9 The coefficients of the new local calibration will be displayed in the column Value. It is also possible to write coefficients directly onto the probe by pushing the button Edit.

Calibrate TSSeq [mg/l]

Calibration type: **Linear**

Sample mode: **Single Measurement**

Calibration of parameter successful. New measurement initiated. Check probe status.
Current value: 4.56 mg/l

Parameter: **OK**

Index	Sample	Raw	Lab
1		5.009 mg/l	4.2 mg/l
2		49.610 mg/l	37.5 mg/l

Save

Name	Value
Coefficient 0 - Offset	0.4599
Coefficient 1 - Slope	0.7466

Edit

Measured value [mg/l] vs Time

Trigger measurement

Enter new values for coefficients

Coefficient 0 - Offset	-0.0966
Coefficient 1 - Slope	0.8577
Coefficient 2	0.0
Coefficient 3	0.0
Coefficient 4	0.0
Coefficient 5	0.0

Only edit the values of the coefficients if you exactly know the calibration function of the sensor and know how to interpret the coefficients.

Cancel Okay

6.2.5 Multiple Sampling using moni::tool

Besides the two samples directly stored onto the spectrometer probe it is possible to gather several samples in a calibration database (see section 6). These samples can be used for a linear calibration based on several samples (see section 6.1.3). Multiple sampling will be started by the following steps:

- Click the Service tab of the moni::tool screen and logon as Administrator.
- Click the button Sample & Calibration located top right in the shown overview of the monitoring system.
- A user message will pop up where you can select whether you want to perform a new sample measurement (button Take sample) or edit the existing samples (button Sample list).

Sample & Calibration

You can either take a new sample of all installed sensors or you can manage samples that were already taken and add laboratory result values.



- After selecting Take sample the screen for Sample Configuration will be displayed. In the entry field on top a description can be entered.

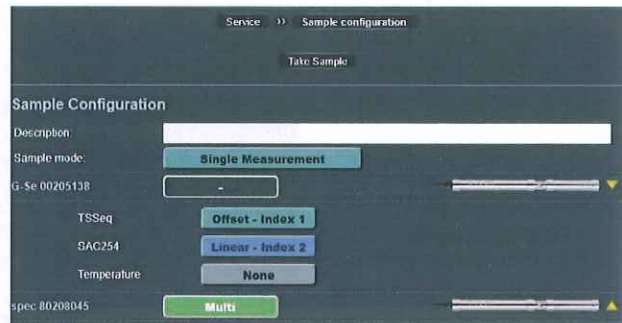

- Either for the probe itself or for each single parameter the intention for sampling can be selected.

- None: Sample will not be stored.
- Offset - Index 1: will be stored in the database and on the probe as sample 1.
- Linear - Index 1: will be stored in the database and on the probe as sample 1.
- Linear - Index 2: will be stored in the database and on the probe as sample 2.
- Multi: will only be stored in database and not on probe.

Select calibration type



Sample-Position: 1 2

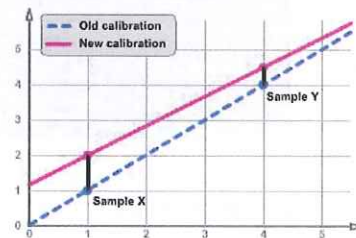

A linear calibration changes the offset and slope of the calibration curve. For a linear calibration two samples and two laboratory values are required. For the best calibration result the samples should be taken at the upper and lower measurement range of the sensor.



- After all settings have been done push the button Take Sample to start the measurement. The progress will be displayed on a separate screen.

Sensor name	Parameter name	Status	Index	Raw
G-Se 00205138	TSSeq	Sample successful	1	5.367 mxt
G-Se 00205138	SAC254	Taking sample, please wait	2	

- As soon as the sampling process is finished the raw values of all parameter samples are displayed. In the column Lab the results of laboratory analysis can be entered. Clicking on the entry field on the right hand side of the raw value will open a new window.

Sensor name	Parameter name	Raw	Lab	Index	Calibrate
G-Se 00205138	TSSeq	5.387 mg/l	NaN mg/l	1	
G-Se 00205138	SAC254	0.152 Abs/m	NaN Abs/m	2	
spec 80203045	Turbidity	0.200 FTUeq	NaN FTUeq	-	
spec 80203045	NO3-Neq	13.533 mg/l	NaN mg/l	-	

- Within this window all information regarding this sample are displayed. The result of laboratory analysis can be entered and stored (button Save) or deleted (button Clear).

Sample 49

Sensor name: **G-Se 00205138**
 Parameter name: **TSSeq**
 Timestamp: **18-Oct-2011 13:27**
 Raw: **5.39 mg/l**
 Lab: **NaN mg/l**
 Sampled: **Sampled on Sensor, index 1.**

Please enter a lab value for this sample.

Cancel Clear Save

- When selecting Sample list in the first user message (see beginning of this section) an overview of all samples stored up to now in the database will be displayed.
- A click on the ID number on the left hand side opens the information screen of this sample.
- A click on the trash icon on the right hand side will delete the complete sample.

ID	Timestamp	G-Se 00205138	spec 80203045	cond 2412	oxi 2324
1	25-Jul-2011 15:05				
2	25-Jul-2011 16:51				
46	13-Oct-2011 18:16				
47	17-Oct-2011 17:17				
48	18-Oct-2011 13:20				
49	18-Oct-2011 13:27				

The calibration screen of moni::tool (see section 6.2.4) offers some additional features when performing a linear calibration with several samples. They are explained in the figure below.

- Calibration type Multi has to be selected.
- ID of all stored samples is displayed.
- Tick the box Use if this samples shall be used for calibration.
- Correlation between laboratory results and raw values is displayed and updated automatically.
- Mean error and confidence Interval is displayed and updated automatically.

Service >> Sensor >> Calibration >> Calibrate Parameter

Calibrate Turbidity [FTUeq] Perform Calibration

Calibration type: **Multi**

Coefficient calculation successful. See chart.

Mean error: 1.366 Confidence Interval: 0.06%

ID	Raw	Lab	Use
46	0.19 FTUeq	0.20 FTUeq	<input checked="" type="checkbox"/>
47	0.19 FTUeq	0.18 FTUeq	<input checked="" type="checkbox"/>
50	0.09 FTUeq	0.00 FTUeq	<input checked="" type="checkbox"/>
51	0.64 FTUeq	0.90 FTUeq	<input checked="" type="checkbox"/>

<< CALCULATED COEFFICIENTS >>

Name	Value
Coefficient 0 - Offset	-0.1264
Coefficient 1 - Slope	1.6072

Lab: 0.00 Raw probe value: 0.50

7 Data Management

7.1 Data Storage

The following information are stored directly on the spectrometer probe:

- Actual used global calibration
- Name, unit, measuring range of up to eight parameters
- Actual used local calibration for each parameter
- Readings of two sample measurements for each spectral parameter
- Laboratory results of two samples for each spectral parameter
- Reference measurement
- Up to 12 different global calibrations (depending on the device type, please refer to section 5.4)
- Device information (e.g. type, serialnumber, address, please refer to section 10.2)
- Service information in the internal probe logfile

Furthermore the spectro::lyser enables logging of either fingerprint results or parameter results for the time the spectrometer probe is operated in logger mode without a controller connected. Please refer to the technical specifications located at the end of this manual regarding amount of data being stored.

7.2 Data Transfer

When spectrometer probe is connected to an s::can controller the results (parameter and / or fingerprint) are transferred to the controller via the probe cable using RS485. Regarding further information for data transfer (e.g. via Modbus or Profibus) please refer to the manual of the used controller.

When spectrometer probe is connected to the con::nect B-23-RTU the parameter readings will be transferred via a gateway to ModbusRTU. This enables direct integration of spectrometer probes into external monitoring systems. Please contact your s::can sales partner regarding further information.

When spectro::lyser is operated in logger mode the results can be downloaded from the probe with ana::pro. Please refer to manual ana::pro for further details.

7.3 Data Visualisation

For visualisation of the spectrometer probe readings one of the following s::can controller can be used:

- con::lyte (up to four parameter readings and time series)
- con::stat (parameter readings, time series and fingerprints in case of spectro::lyser)
- con::cube (parameter readings, time series and fingerprints in case of spectro::lyser)
- con::nect with PC (parameter readings, time series and fingerprints in case of spectro::lyser)

8 Functional Check

A functional check might be required for one of the following reasons:

- Initial startup
- Routine functional check
- Suspicion of monitoring system malfunction
- Modification of monitoring system (e.g. integration of additional sensor or device)
- Change of measuring location

Depending on the application (water composition), the probes and sensors connected and the environmental conditions a regular functional check (weekly to monthly) is recommended. The following sections provide an overview of all the actions that have to be performed to check the monitoring system quickly (see section 8.1), to check the plausibility of the collected readings (see section 8.2) and to check the integrity of a single probe or sensor (see section 8.3). Furthermore you will find an instruction how to check the linearity (see section 8.4) if this is needed.

8.1 Check of System

Check	con::lyte	moni::tool / con::cube	ana::xxx / con::stat
Power supply controller	Green LED is on? Text is visible on the display?	LED on housing cover is on? moni::tool screen is displayed after touching the screen?	LED on housing cover is on? ana::xxx screen is displayed after touching the screen?
System running (up-to-date)	Displayed system time is current and is updated every second? Use arrow buttons.	Click on system clock at the bottom of the screen shows current time and time of last measurement. Both are current?	Time stamp of the last measurement is current?
System status	No error messages or error symbol displayed?	LED of con::cube is blue and <i>Status</i> icon of moni::tool is not blinking yellow?	Green LED of con::stat is on and <i>System status</i> of ana::xxx is <i>Ok</i> and not <i>Warning</i> or <i>Failure</i> ?
Reason for bad system status	Check logbook entries since last functional check.	Open <i>Status</i> tab and select symbol of affected sensor for more information.	Activate <i>Show context help</i> and move cursor to <i>System status</i> .

Check	Remark
Function of automatic cleaning	Use function <i>Clean now</i> or wait for next cleaning cycle. Watch for air bubbles when cleaning is activated or listen if cleaning brush is rotating.
Compressed air supply for automatic cleaning	All tubes and fittings are tight?
Function of compressor and storage tank	Drain condensed water from storage tank of compressor (not necessary for s::can compressor B-32). Check pressure.
Monitoring station (by-pass)	All tubes and fittings are tight and all probes and sensors are supplied with medium? No air bubbles within the tubes?
Submersed Installation (in-situ)	Mounting equipment of all devices is ok and all probes and sensors are submersed?
Data transfer	Check if displayed readings on local controller are equal with displayed readings on customer display system.

8.2 Check of Readings

Check	con::lyte	moni::tool	ana::xxx
Current readings displayed completely	No <u>NaN</u> and no dashes (---,--) or plus sign (++++,++) displayed. Use arrow buttons to scroll through all displayed parameters.	No <u>NaN</u> displayed.	No <u>NaN</u> displayed.
Current parameter status of displayed readings	Check logbook entries since last functional check.	Red background for parameter indicates an error or alarm. Grey background indicates reading is not current.	Activate <u>Show context help</u> if grey background or <u>NaN</u> and move cursor over displayed reading.

Check	Reason	Remark
Up-to-date: Readings actualised on regulary base?	<ul style="list-style-type: none"> - Measuring interval is too long - Automatic measurement has been stopped manually 	Consider measuring interval and smoothing.
Continuity: Check historical data (timeseries) for interruptions or discontinuities	<ul style="list-style-type: none"> - Change of medium - Local calibration - Maintenance of probe / sensor (cleaning, etc.) - Readings out of range - System failure (loss of power, communication error, etc.) 	Only possible if timeseries are availbale.
Plausibility: Timeseries look plausible with daily or seasonal fluctuation	<ul style="list-style-type: none"> - Drift of readings (can be caused by fouling) - Increasing noise (can be caused by flow conditions or fouling) - Fixed readings / no fluctuation 	Check logbook of plant operator if possible.
Measuring range: Readings are within the specified and calibrated measuring range?		Quality of results might be reduced outside the specified range.
Accuracy: Difference between laboratory values and readings of the spectrometer probe	In case of significant difference during initial operation a local calibration has to be performed (please refer to section 6). In case of significant difference during normal operation a functional check has to be performed to ensure cleanness of measuring section (optical path).	To verify the accuracy of the displayed readings only a reliable and validated comparison method has to be used.

8.3 Check of Probe - Sensor Integrity

During a functional check the actual reference and the cleanness of the measuring windows will be checked. The operation software ana::lyte, ana::pro, moni::tool or the con::lyte, respectively, will guide you through all necessary steps.

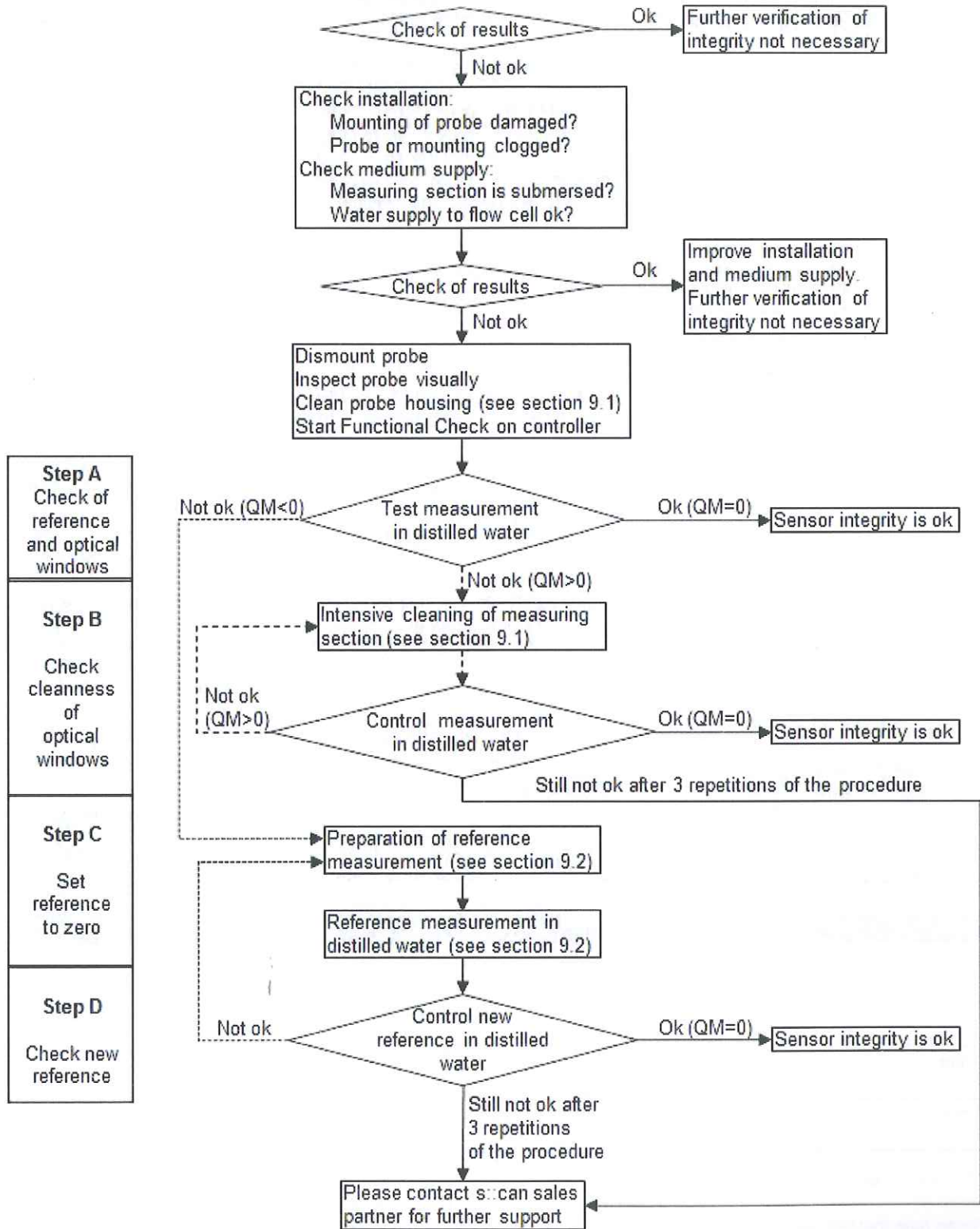

The diagram above gives an overview of the procedure of the software supported functional check, which can be divided into four steps (A to D). Depending on the results of the test measurements that have to be performed in distilled water, these steps will be executed or not.

The software supported functional check is executed as follows:

- A1: Take the spectrometer probe out of the measuring medium.
- A2: General cleaning of the probe and careful cleaning of the measuring section. The measuring windows themselves must not be cleaned at this point. Finish the cleaning procedure by rinsing with distilled water. Start the functional check in the operating software or on the controller, respectively (see manual ana::lyte, moni::tool or con::lyte, respectively).
- A3: Place the carefully cleaned multifunctional slide over the cleaned measuring section of the spectrometer probe.
- A4: Fill the multifunctional slide with distilled water and pour it out. Rinse the multifunctional slide several times (at least 3 times) in this way.
- A5: Fill the multifunctional slide once again with distilled water.
- A6: Start execution of functional check (entry *Functional Check*, *Execute Check* or *Check*).

Test measurement: The probe now executes a measurement. Once the measurement has been finished a quality number (Indicator = -2 to +2) will be displayed. According to this the following actions are necessary:

- Q = 0: The probe is fully operative and can be mounted again without any modification (sensor integrity is ok).
 - Q < 0: A new reference measurement is necessary (see section 9.2).
 - Q > 0: Suspicion of window fouling.
- B1: Thoroughly clean the measuring section again.
 - B2: Thoroughly clean measuring windows.
 - B3: see A3
 - B4: see A4
 - B5: see A5
 - B6: see A6

If the quality number is still > 0 after the 3rd repetition of this procedure please continue as follows:

- Q = 1: Perform a new reference measurement (see section 9.2).
- Q = 2: Inform your local s::can sales partner.

Alternatively, for experienced users it is also possible to assess the status of the measuring windows and reference measurement by looking at the spectra recorded when distilled water is measured and comparing these with the zero / background line. When using of the software controlled functional check this evaluation is done fully automatic.

8.4 Check of Probe - Linearity

After the sensor integrity has been ensured (see section 8.3), the linearity of the spectrometer probe can be verified using standard solutions. Standard solutions for nitrate and COD / TOC (based on potassium hydrogen phthalate) can be used for checking the probe's linearity. Different concentrations are required for the different pathlengths, and the appropriate concentrations are listed in the table below. Because the standard solutions are different, spectrally, from real applications, it is necessary to activate the global calibration GCHECK, before performing the linearity check. Please refer to the s::can manuals of your operation software (ana::lyte, ana::pro, moni::tool or con::lyte) for information on how to activate global calibrations.

Optical path length	Accuracy ¹⁾ of NO ₃ -N [mg/l]	Accuracy ¹⁾ of TOC [mg/l]	Accuracy ¹⁾ of COD [mg/l]
100 mm	for 0 - 3 mg/l +/- (2% + 0.01 mg/l)	for 0 - 20 mg/l +/- (2% + 0.1 mg/l)	
35 mm	for 0 - 9 mg/l +/- (2% + 0.03 mg/l)	for 0 - 50 mg/l +/- (2% + 0.3 mg/l)	
5 mm	for 0 - 60 mg/l +/- (2% + 0.2 mg/l)	for 0 - 350 mg/l +/- (2% + 2 mg/l)	for 0 - 750 mg/l +/- (2% + 2 mg/l)
2 mm	for 0 - 150 mg/l +/- (2% + 0.5 mg/l)		for 0 - 1800 mg/l +/- (2% + 5 mg/l)

¹⁾ Accuracy is the degree of closeness of a measured quantity to its true value, also known as reference value.

Please note that this verification of linearity is not necessary to ensure the technical performance of the spectrometer probe. The technical integrity is automatically tested during each measurement by selfdiagnostic functions of the probe. However, to fulfill specific QA/QC standards it might be necessary to verify the performance of the spectrometer probe using standards. In such a case this procedure needs to be followed.

9 Maintenance

9.1 Cleaning

During routine operation the cleaning of the spectrometer probe, i.e. the optical measuring windows of the instrument, is performed automatically either via compressed air system or via rotating brush (autobrush) in the flow cell. To clean the probe manually the following is recommended:



Before demounting the probe be sure that automatic air cleaning is deactivated via operating software and air supply line is depressurised to avoid dirt and / or injury by suddenly escaping pressurized air.

- Rinse sensor with hand-hot drinking water to remove coarse deposits.
- Put the probe in a bucket of hand-hot drinking water for several minutes to remove deposits on and in between the measuring gap.
- To clean the sensor housing (not the measuring gap with the measuring windows) a soft cleaning agent (e.g. dish-washing detergent) can be used.



When cleaning the measuring windows, care has to be taken that the windows are not damaged (do not use abrasive materials such as scouring sponges or stiff brushes).

The cleaning of the measuring windows is performed using a soft cloth (one that does not leave behind fibres), cotton swabs or paper tissues that are moistened with cleaning liquid before they are applied. Furthermore, cleaning tissues for eye glasses, e.g. available in supermarkets, are suited. For the removal of strongly adhering fouling, s::can cleaning brushes are available.

The use of the following liquids is allowed for cleaning of the windows. The liquids are listed in the order in which they are to be used in case fouling is persistent.

- Water (can be mixed with a commercial liquid dishwashing agent)
- Pure alcohol (Ethanol)
- s::can cleaning agent
- 3% Hydrochloric acid (HCl) in case of mineral film on the windows



All cleaning liquid must only be applied on the windows using cleaning cloth or tissue. Rinse with distilled water directly after the cleaning. Otherwise the residue of cleaning agents may change the optical characteristics of the windows under UV light and thus lead to a distortion of measurements.

After every step undertaken in the cleaning process, the measuring compartment must be rinsed with sufficient amounts of distilled water.



Sometimes it is possible that the air introduced by the automatic cleaning causes oxidation reactions to take place in the water. As a result, thin films of Fe / Mn / Ca can be formed. When the risk exists that such deposits are formed, it is recommended to use a very brief cleaning time only (1 – 2 seconds) and to reduce cleaning frequency (one cleaning cycle per hour) or to use drinking water instead of air for the automatic cleaning. When using an optical pathlength of 35 mm or 100 mm the rotating brushes of the autobrush flow cell (F-446-1 or F-446-2) will avoid such coatings of oxidized Fe / Mn / Ca.

9.2 Reference Measurement

All s::can spectrometer probes will be delivered with a high quality reference measurement and therefore can be used at once. The reference measurement serves to define the zero point of all wavelengths that are measured by the spectrometer probe.



A new reference measurement shall only be performed due to result of a performed functional check (see section 8.3) or if recommended from your s::can sales partner. As faulty reference measurement will lead to falsification of all subsequent readings, replacing a reference measurement has to be done with great care.

- Thoroughly clean the measuring section, the measuring windows (see section 9.1) as well as the multifunctional slide.
- Place the carefully cleaned multifunctional slide over the cleaned measuring section of the spectrometer probe.
- Fill the multifunctional slide with distilled water and pour it out. Rinse the multifunctional slide several times (at least 3 times) in that way.
- Fill the multifunctional slide once again with controlled distilled water.
- Start the reference measurement (see manual analyte, moni::tool or con::lyte). The measurement ends automatically and replaces the last reference measurement.
- Check the new reference measurement by means of the functional check (quality number Q = 0) or manual measurement in the reference medium (Fingerprint = zero).



High quality distilled water must be used for the reference measurement. In this context, please ensure that it contains no foreign matter (e.g. air bubbles, contamination) whatsoever! There is no way to check the quality of the distilled water used automatically.

For the highest possible accuracy of measurements, it is recommended to perform the reference measurement at the temperature and with the probe in the same orientation as it will be used when the probe is installed.



Poor referencing (e.g. when the measuring windows have not been properly cleaned or there are traces of cleaning agents on the measuring windows) may reduce the quality of the readings provided by your spectrometer probe.

10 Troubleshooting

10.1 Typical Error Pattern

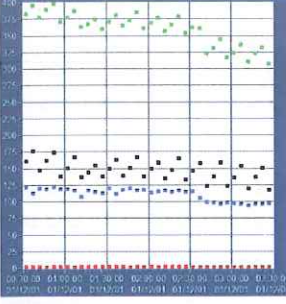
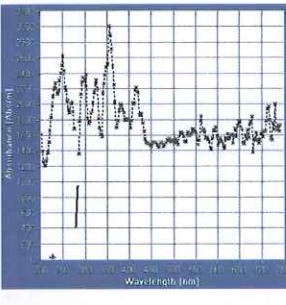
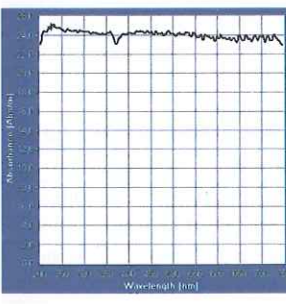
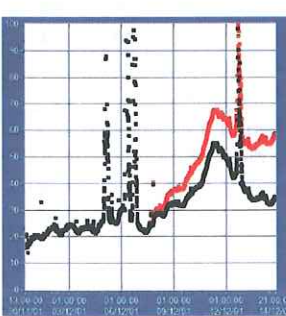
Reason	Removal
	<p>Sedimentation on optical path influences the absorbance signal.</p> <ul style="list-style-type: none"> ■ Improve installation (orientation of optical path) ■ Cleaning before each measurement
	<p>Complete fingerprint out of range. Measuring section blocked.</p> <ul style="list-style-type: none"> ■ Check medium and measuring section ■ Clean measuring section ■ Perform functional check
	<p>Spectrometer probe is measuring on air</p> <ul style="list-style-type: none"> ■ Check installation and medium supply ■ Ensure measuring section is submersed at all times
	<p>Fouling on optical windows influences measurements</p> <ul style="list-style-type: none"> ■ Check automatic cleaning ■ Improve cleaning settings ■ Perform manual cleaning

10.2 Error Messages / Status Messages

During execution of a measurement or a parameter calibration the status of the monitoring system (system status), the measuring device itself (device status) and the result (parameter status) will be checked for possible errors and for plausibility. The device and the parameter status are separated into a general part (valid for all measuring devices) and an individual part (valid for the respective measuring device). In case of an error or a faulty calibration a user message will be displayed to the operator (status bit will be set from 0 to 1).

Depending on the used controller these messages will be shown on the display (*Logbook* in case of con::lyte, *Show Context Help* and *System-Status* in case of ana::xxx and *Status* tab in case of moni::tool). Additional to the general error reason the detailed status code will be displayed in binary form (0000, 0001, 0010, 0011, 0100, etc.) or as a hex number (0001, 0002, 0004, 0008, 0010, etc.).



If several errors occur at the same time the con::lyte and moni::tool will add up all the status codes (status code 8000 means that only error bit b15 is active whereas status code 4011 means that error bits b0 (0001), b4 (0010) and b14 (4000) are active at the same time).

The table below shows all possible errors regarding the controller (system status) when a spectrometer probe is connected incl. the user message, the reason of the error and notes for trouble shooting. If the error can't be removed although the suggested procedure was executed several times please contact your s::can sales partner.

Status System (Statusbit / Code)	System message	Reason	Removal
ES001 (con::lyte)	Wrong G-Serie-SW-version: ~.~.~. Upgrade of probe necessary!	Software version of spectrometer probe is invalid. It cannot be used to operate the probe.	Update is required! Contact s::can sales partner.
ES002 (con::lyte)	Wrong G-Serie mode. Stop 'logger' first and push button Enter.	Spectrometer probe is in logger mode. Operation of this probe is not possible.	Use ana::xxx to exit logger mode.
ES003 (con::lyte)	The G-Serie has no serialnumber. Use another probe and push button <i>Enter</i> .	Invalid S/N of spectrometer probe. Operation of this probe is not possible.	Set S/N to right serial number. Internal battery might be empty.
ES004 (con::lyte)	G-Serie: No valid s::canpoint. Select another global calibration.	No data stored under name of s::canpoint or global calibration currently used.	Create a new s::canpoint and select another global calibration from the spectrometer probe.
ES005 (con::lyte)	G-Serie: measurement period failure. Select another global calibration.	Settings for the s::canpoint result in measuring time which is too long (longer than 5 minutes).	Create a new s::canpoint and select another global calibration from the spectrometer probe.
ES006 (con::lyte)	Protocol failure. Code:~.~.~. Probe with RS485? Reset your probe!	Communication error to probe (protocol failure), maybe problem on RS485 BUS, 2 nd probe with the same address on bus, maybe no RS485 probe, maybe con::lyte or probe defect.	Restart the controller. For further information see manual con::lyte.
ES007 (con::lyte)	Probe not detected	No probe connected, no power connected, no supply to connected probe.	Check connection and power supply of probe. Check parameter configuration.
ES008 (con::lyte)	com-error		Restart the controller. For further information see manual con::lyte.

Status System (Statusbit / Code)	System message	Reason	Removal
b0 - xxx1		Door is open	
b1 - xxx2		Service mode is active - all measurements are stopped.	Quit Service mode (button Leave Service Mode or log out).
b2 - xxx4		Door is open and login period expired.	
b3 - xxx8	Alarm	At least one unconfirmed alarm is active.	Confirm the pending alarms.
b4 - xx1x	Failure	At least one check failed. For further details see additional status messages.	If no further information available, note error code and contact s::can sales partner.
b5 - xx2x		Update DB is running.	Wait until database update is completed.
b15 - 8xxx		System status could not be calculated.	Wait for the next measurement. If error persists, re-boot controller.

The table below shows all general errors regarding the measuring device itself (sensor status general) incl. the user message, the reason of the error and notes for troubleshooting. If the error can't be removed although the suggested procedure was executed several times please contact your s::can sales partner.

Status Sensor general (Statusbit / Code)	System message	Reason	Removal
b0 - xxx1 ES100 (con::lyte)		s::can device reports error during internal check.	
b1 - xxx2 ES101 (con::lyte)		PROBE MISUSE Operation outside the specification!	
b2 - xxx4		Missing or defect component detected.	
b3 - xxx8	Data Logger Error	No measurements can be stored because the data logger is full.	Clear data logger after data have been downloaded.
b13 - 2xxx		Device busy	Repeat function.
b14 - 4xxx		Device cleaning required	Perform cleaning according to instruction in the manual.
b15 - 8xxx		Device maintenance required	Perform functional check according to the manual.

The table below shows all specific errors regarding the spectrometer probe itself (sensor status private) incl. the user message, the reason of the error and notes for troubleshooting. If the error can't be removed although the suggested procedure was executed several times please contact your s::can sales partner.

Status Sensor individual (Statusbit / Code)	System message	Reason	Removal
b0 - xxx1		Actual used reference measurement is invalid.	Perform a new reference measurement.
b1 - xxx2		Data logger is full. Measurements on the probe are stopped.	Download data and restart logger or switch to storage mode <i>circular</i> .
b2 - xxx4		Medium pressure is too low (outside of specification). Pressure < Lower Limit	Contact s::can sales partner.
b3 - xxx8	Probe MISUSE!	Medium pressure is too high (outside of specification). Pressure > Upper Limit	Take the probe out of the medium and reduce medium pressure!
b4 - xx1x ES010, ES017 (con::lyte) ST019L (ana::xxx)	Voltage too low Probe MISUSE!	Power supply of spectrometer probe is too low.	Check power supply of this probe. Increase voltage.
b5 - xx2x ES010, ES018 (con::lyte) ST019H (ana::xxx)	Voltage too high Probe MISUSE!	Power supply of spectrometer probe is too high.	Check power supply of this probe. Reduce voltage.
b6 - xx4x		Internal humidity is too low (outside of specification). Humidity < Lower Limit	Contact s::can sales partner.
b7 - xx8x		Internal humidity is too high (outside of specification). Humidity > Upper Limit	Take probe out of the medium. Contact s::can sales partner.
b8 - x1xx ES010, ES014 (con::lyte) ST017L (ana::xxx)	Medium temperature too low Probe MISUSE!	Environmental temperature of probe is too low (outside of specification). No measurements possible.	Remove probe from medium immediately. Check temperature. Check additional messages displayed on the controller.
b9 - x2xx ES010, ES015 (con::lyte) ST017H (ana::xxx)	Medium temperature too high Probe MISUSE!	Environmental temperature of probe is too high (outside of specification). No measurements possible.	Remove probe from medium immediately. Check temperature. Check additional messages displayed on the controller.
b10 - x4xx		Probe energy failure (darknoise too high).	Note error code and contact s::can sales partner.
b11 - x8xx		Probe compensation failure (Standard Derivation too high).	Note error code and contact s::can sales partner.
b12 - 1xxx		Probe energy failure (Overflow).	Note error code and contact s::can sales partner.
b13 - 2xxx		Probe compensation failure (Overflow).	Note error code and contact s::can sales partner.
b14 - 4xxx		Probe compensation failure (below lower limit).	Note error code and contact s::can sales partner.
b15 - 8xxx		Probe compensation failure (above upper limit).	Note error code and contact s::can sales partner.

The table below shows all general errors regarding the measured parameters (parameter status public) incl. the user message, the reason of the error and notes for troubleshooting. If the error can't be removed although the suggested procedure was executed several times please contact your s::can sales partner.

Status Parameter general (Statusbit / Code)	System message	Reason	Removal
b0 - xxx1 EP100 (con::lyte)	General parameter error	At least one internal parameter check failed. For details see additional status messages.	In case no further messages are shown, note the error code and contact s::can sales partner.
b1 - xxx2 EP100 (con::lyte)	Parameter error, hardware error	Probe / sensor signal not ok.	Perform a functional check for further information.
b2 - xxx4 EP100 (con::lyte)	Parameter error, configuration error	Invalid parameter configuration	Change local calibration or switch back to global calibration. Select another global calibration.
b3 - xxx8 EP100 (con::lyte)	Parameter error, medium error	The probe is outside of the medium or in incorrect medium.	Check water supply und check whether the probe is fully submersed. If medium is ok, perform functional check for further information.
b4 - xx1x EP100 (con::lyte)	Parameter error, incorrect calibration	At least one of the calibration coefficients is invalid (NaN)	Check readings and lab values, repeat local calibration, restart the probe by disconnecting and reconnecting.
b5 - xx2x	Parameter not available or not ready	Parameter not activated on the probe or sensor still warming up.	Activate parameter on probe or wait until start-up is completed.
b11 - x8xx		Maintenance necessary	Perform functional check according to the manual
b12 - 1xxx		Marked as not full trust by data validation algorithm	
b13 - 2xxx ALARM01		Status of alarm parameter is ALARM	
b14 - 4xxx ALARM10		Status of alarm parameter is WARNING	

Status Parameter general (Statusbit / Code)	System message	Reason	Removal
b15 - 8xxx EP100, IP003 (con::lyte)	Reading out of measuring range	Reading outside the measuring range of the global calibration that is ensured by laboratory analytic.	Check water supply and medium.
EP-01, -02, -03, -05, -06, -08, -09, -12	Parameter error	Parameter value cannot be determined on the basis of the global calibration.	Deactivate this parameter, use another global calibration.
EP-04	Parameter error	Parameter value or absorption cannot be determined.	Check measuring path, medium and cleaning. Perform functional check.
EP-10		Parameter value cannot be determined. Value outside the upper optical measuring limit (too low energy on receiver).	Check measuring path, medium and cleaning. Perform functional check.
EP-11		Parameter value cannot be determined. Value outside the lower optical measuring limit (more energy on receiver than during reference measurement).	Check measuring path, medium and cleaning. Perform functional check.
EP-07, EP-13	Invalid local calibration	Local calibration cannot be used.	Perform new local calibration or change to global calibration.
EP-14	Nonspectral parameter problem	Input value or calculated value of non-spectral parameter of spectrometer probe is invalid.	Deactivate this parameter, select another global calibration.
EP-17	Unknown parameter failure	Unidentified error. Invalid parameter result.	Select another global calibration.

10.3 Device Settings

10.3.1 Check / Modification of Device Settings using con::lyte

The main menu entry *Information* of the con::lyte operation software enables you to check and partially modify internal probe settings. After selecting the parameter of your interest by pushing the *Enter* button the display will show the *upper limit* and the *lower limit* of the selected parameter.

TSSeq [mg/l]	
Upper limit:	3000.0
Lower limit:	0.0
Probe	

When confirming the lowest entry *Probe* with *Enter* the following information will be displayed:

- Serial number of the spectrometer probe (*S/N*)
- Firmware version of the spectrometer probe (*SW-version*)
- Actual used operation mode of the spectrometer probe (*Mode*)
- Type of the spectrometer probe, i.e. UV-VIS or UV (*Probe*)
- Indication if a cuvette is used for measurement, default is *Normal*, i.e. without cuvette (*Meas.path*)
- Length of optical measuring path (*Pathlength*)
- Length of optionally used insert to reduce path length (*Insertlength*)
- Name of actual used reference measurement (*Reference*)
- Date and time when last reference measurement has been performed (*Date*)
- Name of global calibration actually used on spectrometer probe (*G.K.*)

Probe	
S/N:	09210316
SW-version:	V0.08.u
Mode:	Online
Probe:	UV-VIS
Meas.path :	Normal
Pathlength:	2mm
Insertlength:	0mm
Reference:	DIST_H2O
Date:	03-02-11 14-13
G.K.:	INFLUH2SV160

Within the operation software of the con::lyte only the used global calibration can be changed and a new reference measurement can be performed within the functional check. Please refer to the manual con::lyte for further details.

10.3.2 Check / Modification of Device Settings using ana::lyte / ana::pro

The ana-xxx operation software enables you to check and partially modify settings of the spectrometer probe. Using the menu item *Help / About ana-xxx.exe* will display the following information of the used spectrometer probe:

- Serial number of the spectrometer probe (*S/N*)
- Type of the spectrometer probe, i.e. UV-VIS or UV (*detector*)
- *Mode* of the spectrometer probe, i.e. spectro::lyser or G-Serie
- Name (*s::canpoint*) and creation date (*from*) of the actual used s::canpoint
- Name of global calibration actually used on spectrometer probe (*Global calib.*)
- Length of optical measuring path (*Pathlength*)
- Name of actual used reference measurement (*Reference*)

Using the menu item *Extra / Configuration...* in the main menu of ana::pro or in the advanced mode of ana::lyte enables you to modify the optical path length if an insert or a cuvette will be used for measurement.

Please refer to the manual ana::lyte / ana::pro for further details.

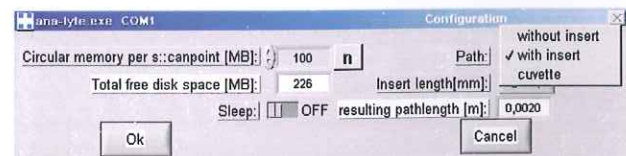
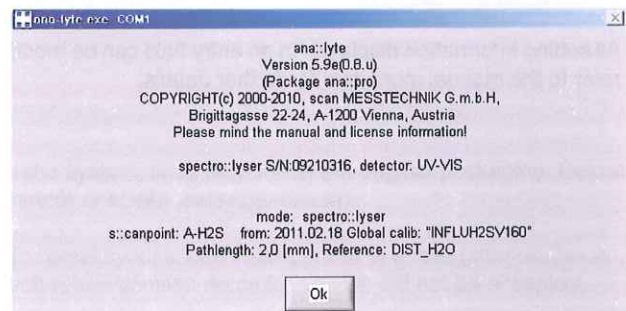

10.3.3 Check / Modification of Device Settings using moni::tool

Selecting *Menu / Settings / Sensor* will list up all devices actually installed on the monitoring system. When clicking on the blue wheel located on the right hand side of the spectrometer probe the following information will be displayed:

- Interface (COM-port, address) of the probe (*Address*)
- *Sensor Name* allocated to the device by the operator
- Measuring location of the spectrometer probe (*Location*)
- Manufacturer name of the spectrometer probe (*Vendor*)
- Type of the probe (*Model*)
- Internal number of the probe (*ID*)
- Serial number of the spectrometer probe (*Serial Number*)
- Actual hardware version of the spectrometer probe (*HW Version*)
- Actual software version of the spectrometer probe (*SW Version*)
- Number of available parameters (*Parameter count*)
- Supported moni::tool functions for the spectrometer probe (*Service actions*)
- Cleaning device allocated to the spectrometer probe (*Cleaning device*)
- Information regarding the purchase (*Purchase date*, *Warranty expiry date*)
- Name of operator who has installed the spectrometer probe (*Installed by*)
- Actual used operation mode of the spectrometer probe (*Measurement mode*)
- Actual used measuring interval of the spectrometer probe (*Measurement interval*)
- *Logging interval for Datalogger* of the spectrometer probe in min.
- *Optical Path Length* of the spectrometer probe in mm
- Name of *Active Global Calibration* actually used on spectrometer probe
- Type of the spectrometer probe, i.e. UV-VIS or UV (*Detector Type*)
- Actual used mode of allocated *cleaning* device (e.g. automatic, manual off)
- Actual used cleaning interval (*Time between cleaning*) in sec.
- Actual used cleaning duration (*Cleaning duration*) in sec.
- Actual used waiting time (*Delay after cleaning*) in sec.
- *Device Model* of the spectrometer probe
- *s::can Bus Protocol Version* of the spectrometer probe

All setting information displayed in an entry field can be modified by the user if needed. Please refer to the manual moni::tool for further details.

Edit sensor	
Address	s::can_bus #11
Sensor name	35mm UV spectro
Location	default
Vendor	s::can
Model	spectro_lyser
ID	0000043c
Serial number	00205138
HW Version	0100
SW Version	0118
Parameter count	9
Service actions	196.0;197.0;198.0;1
Cleaning device	*
Purchase date	2000-01-01
Warranty expiry date	2000-01-01
Installed by	Administrator
EXTENSIONS	
Measurement mode	manual
Messdauer (Sek.)	55
Logging Interval for Datalogger (min) (0 = no logger active)	10
Optical Path Length (mm)	35.0
Active Global Calibration	ALARM090V160
Detector Type	uv/vis
Cleaning	no cleaning suppo
Time Between Cleanings (sec)	300
Cleaning Duration (sec)	3
Delay after Cleaning (sec)	20
Device Model	1.1
s::can Bus Protocol Version	1.6

10.4 Software Update

System Requirements: spectrometer probe (already equipped with bootloader firmware)
 s::can controller or PC with connect
 Java Runtime Environment JRE V1.4 or higher (can be downloaded from java.oracle.com)
 update package for spectrometer firmware



In case your spectrometer probe is not equipped with bootloader software (delivery date before June 2011) please ask your s::can sales partner for separate update package for spectrometer bootloader.

- Start the Task Manager on your s::can controller (please refer to manual of the used controller) and close the operating software.
- Copy the update package onto your s::can controller and unzip the file. The folder should have the structure as displayed on the right.
- Start the download tool with double click on file UpdateSW.jar.
- Select the used COM-port the spectrometer probe is connected to and push the button Ok.
- The download procedure will be started automatically and will be finished within a few minutes.

Name	Anderungsdatum	Typ	Größe
Images	23.05.2011 18:36	Dateiordner	
UpdateSW_lib	23.05.2011 18:36	Dateiordner	
note_spectro_update_firmware_20110523_d.pdf	23.05.2011 13:30	Adobe Acrobat Do...	174 KB
note_spectro_update_firmware_20110523_e.pdf	23.05.2011 13:32	Adobe Acrobat Do...	173 KB
ntx-2.1-7-bins-r2.zip	23.05.2011 14:08	ZIP-Komprimierel...	577 KB
ntxSerial.dll	07.04.2011 18:21	Anwendungserwel...	76 KB
UpdateSW.jar	23.05.2011 18:17	Executable Jar File	67 KB
UpdateSW.properties.bak	21.04.2011 16:04	BAK-Datei	1 KB

With moni::tool V1.4 it is possible to update firmware of the spectrometer probe directly from the operating software. Click the Service tab and select the spectrometer probe you want to update in the system overview. Now select menu item Firmware update and follow the instruction on the screen.

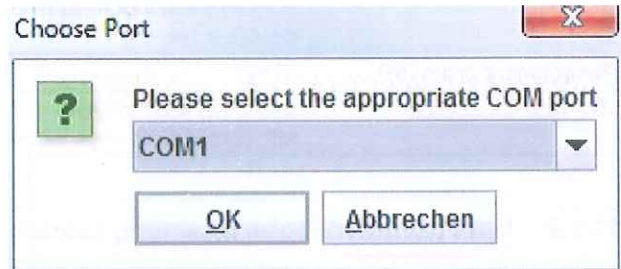

10.5 Return Consignment (RMA)

Return consignments of the s::can measuring system, or parts of the system, shall be done in the original packaging. Before returning a consignment, you have to contact your s::can sales partner or s::can (sales@s-can.at).

In case servicing of your s::can system is required, you also have to contact your s::can sales partner or s::can (service@s-can.at) in advance. You will be assigned an RMA number, without which return consignments for service will not be accepted.

The customer has always to bear the costs for return consignment.

11 Accessories

11.1 Installation

11.1.1 Extension Cable

The cable of the spectrometer probe can be elongated when necessary with an extension cable (10 m, 20 m or 30 m length). The extension cable is attached using the probe cable connector plug.

Name	Specification	Remark
Item-no.	C-210-spectro C-220-spectro C-230-spectro	
Cable length	10 m 20 m 30 m	C-210-spectro C-220-spectro C-230-spectro
Assembling	ex works	
Material	polyurethane jacket with double screening	cable
Environment rating (IP)	IP 68	
Interface connection	IP 68, RS 485, 12 VDC MIL connection	to s::can probe cable and controller



11.1.2 Spectrometer Probe Mounting (horizontal)

For proper, horizontal submersed installation of the spectrometer probe a separate probe carrier is available. This part can be extended by a pipe (to be provided by the customer), if necessary. For length > 1 m stainless steel pipes are preferred.

Name	Specification	Remark
Item-no.	F-110-spectro	
Scope of delivery	1 mounting pipe 2 spacer rings 3 fixing screws (M5x10)	
Material	PVC POM stainless steel	mounting pipe spacer rings fixing screw
Dimensions	63 / 487 mm	diameter / length
Weight	approx. 0.9 kg	
Process connection	ID 50 mm	to mounting pipe OD 50 mm
Installation / mounting	submersed (in situ)	

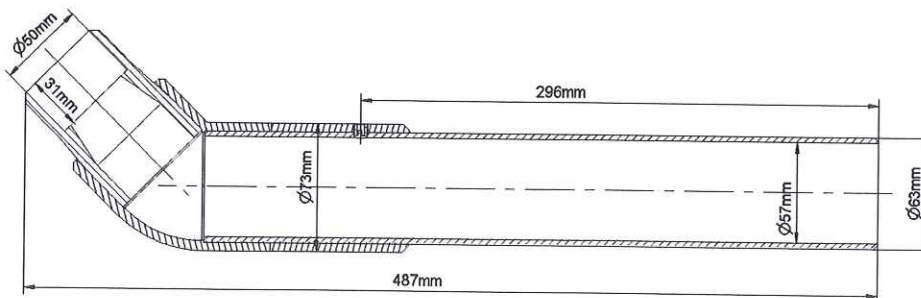

11.1.3 Spectrometer Probe Mounting (vertical)

For proper, vertical submersed installation of the spectrometer probe a separate probe carrier is available. This part can be extended by a pipe (to be provided by the customer), if necessary. For length > 1 m stainless steel pipes are preferred.

Name	Specification	Remark
Item-no.	F-120-spectro	
Scope of delivery	1 mounting pipe 2 spacer rings 3 fixing screws (M5x10)	
Material	PVC POM stainless steel	mounting pipe spacer rings fixing screw
Dimensions	63 / 408 mm	diameter / length
Weight	approx. 0.6 kg	
Process connection	ID 50 mm	to mounting pipe OD 50 mm
Installation / mounting	submersed (in situ)	

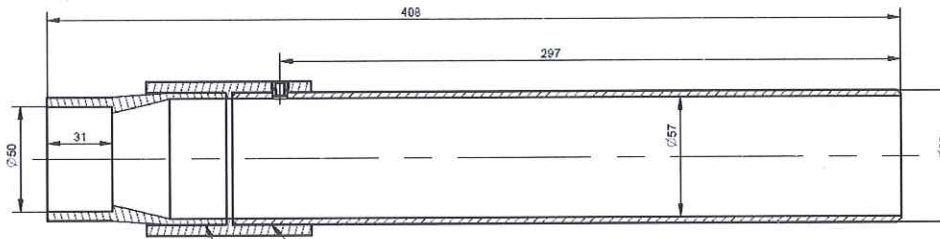

11.1.4 Fixing Adapter

For proper and easy mounting of installation pipes onto the railing a separate fixing adapter carries is available.

Name	Specification	Remark
Item-no.	F-15	
Material	Stainless steel	
Dimensions	158 / 267 / 73 mm	W / H / D
Weight	approx. 2.6 kg	
Process connection	ID 50 mm	OD installation pipe
Installation / mounting	OD up to 64 mm	on rail



11.1.5 Flow Cell Setup Tap Water

For measurement of sample stream outside the medium with a spectrometer probe a separate flow-through installation is available.

Name	Specification	Remark
Item-no.	F-445-1 F-445-2	up to 35 mm OPL 100 mm OPL
Material	POM-C stainless steel	flow cell mounting
Dimensions	132 / 101 / 74 mm 196 / 101 / 74 mm	F-445-1 W / H / D F-445-2 W / H / D
Weight	approx. 0.45 kg approx. 0.8 kg	F-445-1 F-445-2
Process connection	1/4 inch inside	
Installation / mounting	flow-through (by pass)	
Operating temperature	0 to 60 °C (32 to 140 °F)	
Operating pressure	0 to 6 bar (0 to 87 psi)	
Accessories	Hose nozzle 1/4 inch (ID 6 mm)	F-45-process

F-445-1

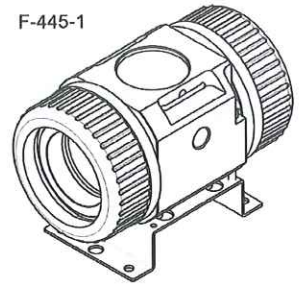

F-445-2

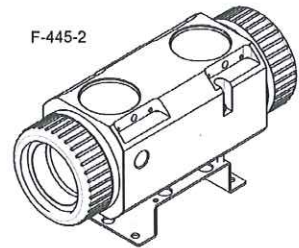

11.1.6 Flow Cell Setup Autobrush

For measurement of sample stream outside the medium with a spectrometer probe in such applications, where fouling of the measuring windows may occur and automatic cleaning is not sufficient or not applicable, a separate flow-through installation with an automatic brush is available.

Name	Specification	Remark
Item-no.	F-446-1 F-446-2	for 35 mm OPL for 100 mm OPL
Material	POM-C stainless steel	flow cell mounting
Dimensions	132 / 155 / 74 mm 196 / 155 / 74 mm	F-446-1 W / H / D F-446-2 W / H / D
Weight	approx. 0.9 kg approx. 1.5 kg	F-445-1 F-445-2
Power supply	10.5 to 13.5 VDC	
Power consumption	1.2 W (typ.)	
Process connection	1/4 inch inside	
Installation / mounting	flow-through (by pass)	
Operating temperature	0 to 40 °C (32 to 104 °F)	
Operating pressure	0 to 6 bar (0 to 87 psi)	
Accessories	Hose nozzle 1/4 inch (ID 6 mm)	F-45-process



For this s::can product a separate manual is available.

11.1.7 Flow Cell Setup Waste Water

For measurement of waste water sample stream outside the medium with a spectrometer probe a separate flow-through installation is available.

Name	Specification	Remark
Item-no.	F-48-spectro	
Material	PVC	
Dimensions	126 / 98 / 177	W / H / D
Weight	approx. 0.65 kg	
Process connection	ID 40 mm	
Installation / mounting	flow-through (by pass)	
Operating pressure	0 to 3 bar (0 to 43.5 psi)	

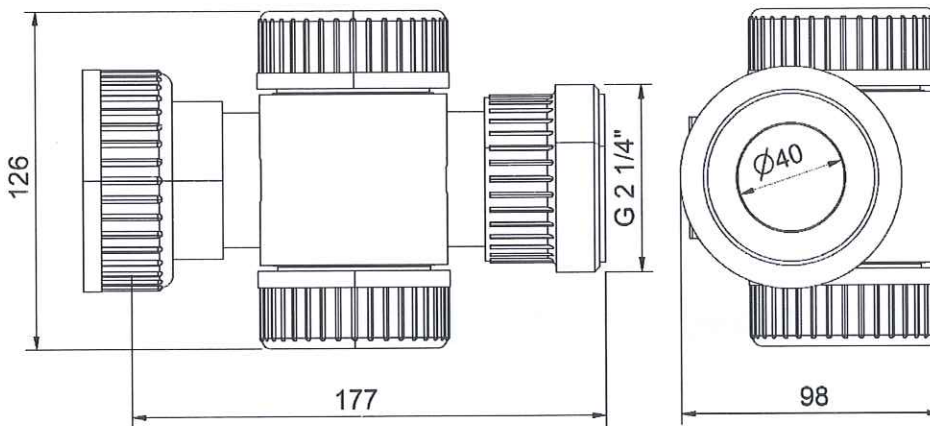
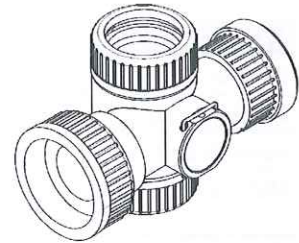

11.1.8 System Panel micro::station

For easy attachment of a complete s::can monitoring system (s::can controller, flow cell autobrush and two other flow cells) a separate system panel with holes for mounting of different devices is available.

Name	Specification	Remark
Item-no.	F-501-eco-eu F-501-eco-us	
Material	PP	
Dimensions	450 / 750 / 10 mm 450 / 750 / 190 mm	W / H / D (panel itself) W / H / D (required depth)
Process connection	G 1/4 inch 1/4 inch NPT	F-501-eco-eu F-501-eco-us

11.2 Automatic Cleaning

11.2.1 Pressure Connection Set

For connection of the automatic air cleaning system of the spectrometer probe a specific pressure connection set is available.

Name	Specification	Remark
Item-no.	B-41-sensor	
Pressure hose	3 m	ID 4mm / AD 6mm
Assembling	ex works	
Material	PU Nickel-plated brass	tube connection fitting
Process connection	$\frac{3}{8}$ inch	
Operating pressure	1 to 6 bar (14.5 to 87 psi)	



11.3 Maintenance

11.3.1 Cleaning Brushes

For easy and proper manual cleaning of the measuring windows of the spectrometer probes specific brushes are available. They are especially suited for mechanical removal of persistent window fouling.

Name	Specification	Remark
Item-no.	B-60-1 B-60-2	for pathlength < 5 mm for pathlength > 2 mm
Dimensions	200 mm	length



11.3.2 Cleaning Agent

For easy and proper manual cleaning of the measuring windows of the spectrometer probes a specific cleaning agent is available. It is especially suited for chemical removal of grease and persistent organic window fouling.

Name	Specification	Remark
Item-no.	B-61-1	
Weight	approx. 1.3 kg	
Volumne	1 000 ml	



11.3.3 Multifunctional Slide

For easy and proper functional check and reference measurements of the spectrometer probe a multifunctional slide is available.

This slide can also be used for measuring individual samples outside the process flow (e.g. spot samples in a laboratory). To place the multifunctional slide without requiring excessive force and risk of damaging the O-rings, the contacting surfaces on the probe, as well as the O-rings of the multifunctional slide can be moistened with water.

After fitting, the multifunctional slide must always be rinsed first using distilled water. This is done to avoid influence of subsequent measurements by traces of O-ring material left on the probe during fitting.

Name	Specification	Remark
Item-no.	B-421-1 B-421-2	up to 35 mm OPL 100 mm OPL
Material	POM-H FPM	housing sealing
Dimensions	100 / 44 / 60 mm 26 mm 160 / 44 / 60 mm 26 / 80 mm	B-421-1: W / H / D circular opening B-421-2: W / H / D oval opening
Volumne	30 ml 40 ml 100 ml	B-421-1: for 5 mm OPL for 35 mm OPL B-421-2
Weight	approx. 0.17 kg approx. 0.26 kg	B-421-1 B-421-2



11.4 Spare Parts

The spectrometer probe is not equipped with any consumables that need to be replaced periodically. Therefore there is no need to store any spare parts.

11.5 Optional Features

11.5.1 Pressure Sensor

The spectrometer probe can be equipped with an optional pressure sensor that is integrated into the end cap of the probe. Regarding detailed information of the optional feature please refer to the technical specifications located at the end of this manual.

11.5.2 Inserts

For adaption or repair of the optical path length different insert are available. The modification should be performed by s::can sales partner or experienced users only.

Name	Specification	Remark
Item-no.	A-500-s A-001-s A-002-s A-005-s A-015-s	for 0.5 mm OPL for 1.0 mm OPL for 2.0 mm OPL for 5.0 mm OPL for 15 mm OPL
Material	stainless steel (ISO 1.4404) saphire	housing optical windows
Scope of delivery	2 inserts with sealing and service tools	



12 Technical Specifications

Name	Specification	Remark
Item-no.	SP-x-yyy-p-s-zz-nnn-x-yyy-p-s-zz-nnn	spectro::lyser G-Serie (no access to raw signal), see section 3.3 for further details
Measuring parameter	depending on type and used global calibration	see section 5.4
Measuring principle	UV-Vis (220 - 720 nm) and UV (220 - 390 nm) spectrometry	xenox flash lamp, 256 photo diodes, two beam instrument, complete spectrum and compensation
Measuring range	depending on optical pathlength (OPL)	
Resolution	UV-Vis: 2.5 nm UV: 1.0 nm	reduced spectral resolution as stored as result (fingerprint)
Response time	60 sec.	
Accuracy spectro::lyser	NO ₃ -N: +/- 2% + 1/OPL [mg/l] COD-KHP: +/- 2% + 10/OPL [mg/l]	in standard solution (>1 mg/l) OPL ... optical pathlength
Accuracy G-Serie	NO ₃ -N: +/- 3% + 1/OPL [mg/l] COD-KHP: +/- 3% + 10/OPL [mg/l]	in standard solution (>1 mg/l) OPL ... optical pathlength
Repeatability (in air at 20°C)	+/- 0.004 ext. - spectro::lyser +/- 0.010 ext. - G-Serie	in air at 20°C with 10 flashes per measurement without averaging of measurements
Drift (peak to peak)	< +/- 0.005 ext./day - spectro::lyser < +/- 0.010 ext./day - G-Serie	in air at 20°C with 10 flashes per measurement without averaging of measurements
Calibration	global calibration local calibration	preloaded, depending on application to real (local) water matrix possible by customer
Reference	distilled water	e.g. dist. water for analysis by Merck
Automatic compensation	Turbidity, solids, organic substances, etc.	compensation of cross sensitivities
Temperature sensor	-10 to 50 °C (14 to 122 °F) 0.1 °C	range resolution
Pressure sensor (optional)	0 to 1.2 bar (0 to 17.40 psi) absolut 0 to 2 bar (0 to 29.01 psi) absolut 0 to 11 bar (0 to 159.5 psi) absolut	resolution 1:1000 full scale (10 bit), zero referencing before installation recommended (atmospheric effect)
Supply voltage sensor	10 bit	monitoring of power supply
Power supply	11 to 15 VDC, 350 mA <1.5 A 5 mA	full activity during flashing (measuring process) in sleep modus (logger mode)
Power consumption	4.2 W (typical) 20 W (max)	
Electrical potential	max. 1 Ohm < 0.5 Ohm	max. resistance between (power supply) earth (=PE) and the real site ground resistance between the medium to be measured and the ground of the probe's power supply (e.g. con::lyte, con::cube)
Electrical isolation	galvanic isolation	between electronic and housing

Name	Specification	Remark
Length of probe cable	xxx-075: 7.5 m xxx-010: 1.0 m	
Type of probe cable	OD 8 mm +/- 0.5 mm, polyurethane jacket with double screening	min. bending radius 5 cm, no buckling allowed at probe connection
Interface connection	MIL connector, IP 68, RS 485, 12 VDC	to s::can controller
Sensor materials (in contact with measuring medium)	stainless steel 1.4404 X2 Cr Ni Mo 17-12-2 fused silica sapphire (Al ₂ O ₃)	housing (ISO) (DIN material number) measuring windows (OPL 35, 100 mm) measuring windows (OPL < 35 mm)
Weight	3.4 kg 3.7 kg 2.8 kg 3.1 kg	xxx-075, OPL 0.5 - 35 mm xxx-075, OPL 100 mm xxx-010, OPL 0.5 - 35 mm xxx-010, OPL 100 mm ex-approoved + 0.5 kg
Dimension	44 / 547 mm (without cable gland) 44 / 612 mm (without cable gland)	diameter / length (OPL 0.5 - 35 mm) diameter / length (OPL 100 mm) length with pressure sensor: + 25 mm
Operating limits temperature	0 to 45 °C (32 to 113 °F) up to 50 °C (122 °F) < 3 minutes	temperature, min. freezing, max. 45°C submerged
Operating limits pressure	0 to 3 bar (0 to 43.5 psi) up to 10 bar as optional specification	
Operating limits others	max. 3 m/s max. 30 Nm	flowrate mechanical stability, centric load, adequate for most known application conditions and all s::can installation / mounting parts
Storage limits temperature	-10 to 50 °C (14 to 122 °F)	probe has to be acclimatised to medium temperature before initial operation
Installation / mounting	submersed or in flow cell	
Environment rating (IP)	IP 68	
Internal storage	656 KB	for fingerprints or parameters
Back-up battery	5 years life duration without external power supply (e.g. storage)	exchange by s::can service only
Interface to external terminals	Gateway Modbus RTU	via con::ncet
Automatic cleaning - probe connection	G 1/8 inch for air hose OD 6 mm	
Automatic cleaning - specification	compressed air, free of oil & particles min. 3 bar (43.5 psi) max. 6 bar (87 psi)	medium (drinking water alternative) allowed pressure at probe cleaning connection
Automatic cleaning - settings for compressed air	1 to 10 sec. 1 min. to 6 hours >10 sec.	duration (valve is open) interval (depending on application) delay until start of next measurement, (consider possible influence of air bubbles and that flow cell has to be filled up with new medium)
Automatic cleaning - settings for autobrush	1 to 10 sec. 1 min. to 6 hours >10 sec.	duration (brush is rotating) interval (depending on application) delay until start of next measurement, (consider that flow cell has to be filled up with new medium)
Conformity - EMC	EN 61326-1:2006 EN 61326-2-3:2006	general requirements particular requirements
Explosion proof specification	according to EN60079-0, -1, ATEX	

Name	Specification	Remark
Mechanical tests	deviation, shock, temperature 3 bar (43.5 psi)	acc. internal quality criteria leak test
Quality tests	99% within tolerance over 24 hours NO ₃ standard solution 8 fingerprints within specification	precision / stability linearity absorbance in distilled water
Light source	xenon gas discharge lamp	
Stability light source	> 99 % > 99.5 % (typical)	UV-Vis (230 - 650 nm), UV (220 - 350 nm) standard deviation in air at 20°C with 10 flashes
Life time light source	> 1 x 10 ⁹ flashes	Life time = 50 % of output energy; corresponds to about 85% of absorbance / concentration.
Protection light source	shielded, encapsulated	
Regulation light energy	between 60 and 100%	by s::can service only
Flashes per measurement	1 - 20 flashes / measurement 6 flashes (typical)	depending on used global calibration
Assignment of probe cable	Pin A: not used by default Pin B: data+ (RS484) Pin C: data- (RS485) Pin D: not used by default Pin E: output cleaning signal Pin F: 12V power supply Pin G: grounding power supply Pin H: not used by default Pin J: not used by default Pin K: shielding cable not used pins must not be used or set to ground!	pink green violet red, thick black, thick white