

# Dynamics and Control of Cell Populations in Continuous Bioreactors

Prodromos Daoutidis \*

Department of Chemical Engineering and Materials Science  
University of Minnesota  
Minneapolis, MN 55455

Michael A. Henson †

Department of Chemical Engineering  
Louisiana State University  
Baton Rouge, LA 70803-7303

## Abstract

Continuous bioreactors are critical unit operations in a wide variety of biotechnological processes. While they can be viewed as chemical reactors, bioreactors offer unique modeling and control challenges due to the complexity of the underlying biochemical reactions and the distributed properties of the cell population. The dynamic behavior of continuous bioreactors can be strongly affected by variations between individual cells that are captured only with cell population models. The objective of this paper is to outline recent progress in dynamic analysis and feedback control of continuous bioreactors described by cell population models. The industrially important process of continuous yeast production is used to illustrate various concepts. Future research problems in cell population modeling, dynamics and control are outlined to provide insights on the key challenges and opportunities in this emerging area.

## Keywords

Biochemical reactors, Population balance models, Cell population dynamics, Nonlinear control

## Introduction

Biochemical engineering is concerned with the industrial production of biologically based products such as foods and beverages, pharmaceuticals, commodity chemicals, specialty chemicals and agricultural chemicals. The biochemical manufacturing industry is growing rapidly due to dramatic advancements in biotechnology and the high value of biochemical products such as pharmaceuticals (Lee, 1992). Process control has played a rather limited role in the biochemical industry as the economic incentive for improved process operation often is dwarfed by costs associated with research and development. This situation is likely to change with the expiration of key patents and the continuing development of global competition. Another obstruction to process control has been the lack of on-line sensors for critical process variables (Pons, 1992). While this will remain an important issue for the foreseeable future, recent advancements in biochemical measurement technology make the development of advanced process control systems a realistic goal. These trends suggest that biochemical processes will emerge as an important application area for control engineers.

A complete review of the modeling and control needs in the biochemical industry would require a lengthy book rather than a short paper. Therefore the scope of this paper is limited to continuous bioreactors used for the growth of microbial cell cultures important in the food and beverage, pharmaceutical and agricultural chemical industries. Other types of bioreactors (batch and semi-batch) and cell cultures (animal and plant) are not covered despite their industrial importance. The remainder of this section is used to provide an overview of continuous bioreactors with particular emphasis on the process

modeling and control challenges.

## Continuous Bioreactors

A typical biochemical process involves batch, semi-batch and/or continuous reactors in which raw materials are transformed into the desired biological products. In many applications, continuous bioreactors are preferred due to their ease of operation and higher productivity (Lee, 1992). A prototypical continuous stirred tank bioreactor (also known as a continuous fermentor) is depicted in Figure 1. Medium is supplied continuously to the reactor to sustain growth of the microbial cell population. The synthetic medium contains the substrate(s) metabolized by the cells during growth as well as other components such as mineral and salts required to replicate the natural growth environment. The culture is called aerobic if the biochemical reactions involved in cell growth require oxygen as a reactant. In this case, air must be supplied continuously to maintain the necessary dissolved oxygen concentration. By contrast, anaerobic cultures do not require oxygen for cell growth. For each microorganism there is a unique range of culture temperature and pH that support cell growth. A typical bioreactor has simple feedback control loops that maintain the temperature and pH at predetermined setpoints chosen to maximize cell growth (Pons, 1992).

An agitator is used to continuously mix the reactor contents. The agitator speed is chosen to provide satisfactory mixing while avoiding excessive shear forces that may damage cells (Lee, 1992). A stream is removed continuously from the reactor to achieve constant volume operation. The removal rate is characterized by the dilution rate, which is the reciprocal of the reactor residence time. The dilution rate is controlled by a simple feedback controller that manipulates the medium flow rate. The effluent stream contains unreacted substrate and biomass that is a complex mixture of cells and vari-

\*daoutidi@cems.umn.edu

†henson@che.lsu.edu

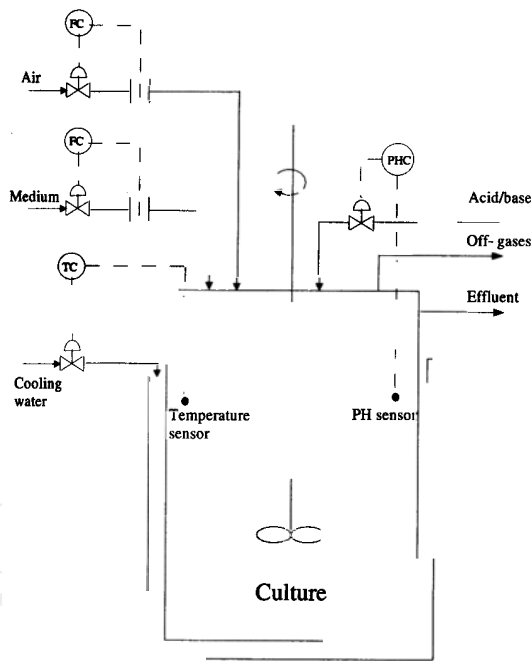

Figure 1: Continuous bioreactor.

### Opportunities for Process Modeling and Control

Mathematical modeling of cell growth kinetics in continuous bioreactors continues to be a major focus of biochemical engineering research (Nielsen and Villadsen, 1994). The potential impact of such models on bioprocess simulation, scale-up, optimization and control is significant. As compared to conventional chemical reactors, bioreactors are particularly difficult to model due to the complexity of the biochemical reactions, the unique characteristics of individual cells and the lack of measurements of key process variables. The consumption of substrates and production of metabolites results from hundreds of coupled biochemical reactions (Mauch et al., 1997). The identification and modeling of these complex reaction networks are very challenging problems usually not encountered in other chemical reaction systems. While it is convenient to view a microbial culture as a homogeneous mixture of identical cells, most cultures actually are comprised of a heterogeneous mixture of cells that differ with regard to size, mass and intracellular concentrations of proteins, DNA and other chemical components (Srienc and Dien, 1992). Accurate modeling of cell growth and product formation kinetics may require that individual cells be differentiated based on these characteristics. While on-line sensors for secondary variables such as carbon dioxide off-gas concentration are available, measurements of primary variables such as the biomass and product concentrations require expensive analytical equipment (Lee, 1992). Accurate and reliable measurement of these primary variables often is required to develop and validate mathematical models.

As shown in Figure 1, a typical control system for a continuous bioreactor consists of simple feedback control loops that regulate reactor residence time, temperature and pH. The control system is designed to supply the prescribed flow of nutrients while avoiding environmental conditions that adversely affect bioreactor productivity. With regards to key output variables such as the biomass and product concentrations, this is an open-loop control strategy based on the unrealistic assumption that unmeasured disturbances have a negligible effect on bioreactor performance. The development of closed-loop control strategies for reactor stabilization and biomass/product optimization would represent a major advance in the biochemical industry.

### Overview of the Paper

The remainder of the paper is organized as follows. Section 2 contains an introduction to the mathematical modeling of continuous bioreactors with an emphasis on cell population models. Section 3 focuses on the dynamic behavior of cell population models with particular emphasis on yeast culture models. The design of feedback controllers using cell population models and the critical issue of on-line measurements are discussed in Section 4.

ous metabolites produced by the cells. Desired products can be the cells themselves, one or more metabolites, or some combination of cells and metabolites. Products are separated from the other components via a series of recovery and purification operations (Lee, 1992). In addition to the liquid product stream, off-gases such as carbon dioxide may be produced as byproducts of the biochemical reactions

Successful operation of a continuous bioreactor requires much more than simply supplying the necessary nutrients and extracting the desired products. Careful preparation of the growth medium is essential as microorganisms are strongly affected by changes in the culture environment. The microorganism must be inoculated in the reactor to initiate cell growth. Typically inoculation is achieved via a multistep procedure in which cells grown in a shake flask are transferred to increasingly larger volume bioreactors until the production bioreactor is inoculated (Lee, 1992). This procedure is necessary to achieve a sufficiently large cell population to sustain growth. A critical requirement is to maintain sterility of the medium and all processing equipment. Even a small amount of contamination can lead to complete loss of productivity and shutdown of the bioreactor. As a result of these complexities, effective operation of continuous bioreactors is a very challenging problem.

Finally our personal perspective on future research in cell population modeling, dynamics and control is presented in Section 5.

## Mathematical Modeling of Cell Growth Dynamics

### Classification and Overview

Mathematical models that describe cell growth processes can be classified into two broad categories:

- *Continuum or unsegregated models* which treat the cell population as a continuum or a lumped bi-phase, i.e. assume that it behaves as a homogeneous entity.
- *Corpuscular or segregated or cell population balance models* which account for the heterogeneous and distributed nature of cell growth, i.e. the fact that a cell population consists of individual cells.

Continuum models include compartmental (Roels, 1983) and detailed metabolic models (see e.g. Nielsen and Villadsen, 1992, and the references therein) which attempt to describe the influence of intracellular metabolism on cell growth, as well as cybernetic models (e.g. Kompala et al., 1986; Straight and Ramkrishna, 1994) which postulate the optimal nature of biomass growth and nutrient uptake in order to predict growth dynamics. The mathematical formulation of continuum models typically leads to a set of nonlinear ordinary differential equations, whereas corpuscular models typically consist of sets of first order partial integro-differential equations coupled with ordinary integro-differential equations that describe substrate consumption and/or product formation.

A second important classification of both continuum and corpuscular models is in *unstructured* and *structured* models. Structured continuum (structured or multi-variable corpuscular) models account for the fact that the lumped biomass (single cell) is comprised of different chemical components, such as DNA, RNA, protein etc, while unstructured continuum and corpuscular models do not. Hence, structured corpuscular models not only account for the fact that cells within a population can behave differently, but they also account for chemical structure within a single cell. On the other hand, in structured continuum models, the chemical structure is included at the cell population level since the continuum approach does not distinguish between different cells.

Moreover, structured or unstructured cell population balance models are assorted in *single-staged* and *multi-staged* models depending on the number of cell cycle stages that are included in the cell population balance formulation. Finally, if the property or properties that are used to describe the intracellular structure obey the mass conservation law, then the cell population balance model is referred to as *mass structured*, whereas if age is

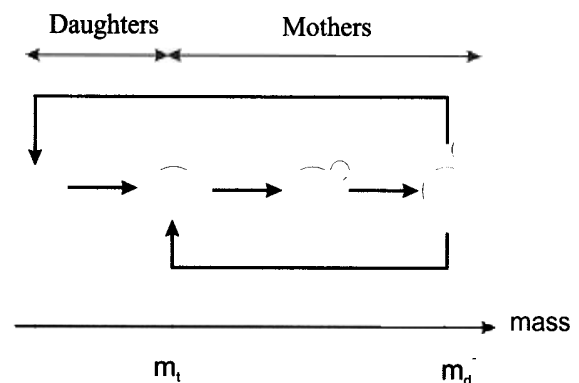

Figure 2: Simplified cell cycle for budding yeast.

used to differentiate each cell from other cells of the population, then the model is referred to as *age structured*.

Due to the level of detail built in their mathematical formulation, structured cell population balance models represent the most accurate way of describing the complicated phenomena associated with cell growth, nutrient uptake and product formation. Moreover, the mathematical formulation of such models naturally allows the incorporation of information about transition between successive cell cycle stages and partitioning of cellular material upon cell division. Furthermore, contrary to continuum models, which can predict only average population properties, cell population balance models are able to predict entire cell property distributions.

### Baker's Yeast: A Motivating Example for Cell Population Balance Models

In what follows, we briefly discuss *Saccharomyces cerevisiae* as an illustrative example of a microorganism for which cell population balance models play a key role in the dynamic analysis and control of its cultures.

*Saccharomyces cerevisiae* is a key microorganism in the brewing, baking and genetic engineering industries. Also known as Baker's yeast, it has been widely studied due to its own importance as well as to understand the behavior of more complex cells present in plants and animals. It can be grown in aerated continuous bioreactors by feeding a nutrient stream containing glucose substrate. A variety of products including ethanol are produced.

A distinctive feature of yeast cells is that they divide via an asymmetric process known as budding (Hjortso and Nielsen, 1994). A simplified depiction of the yeast cell cycle is shown in Figure 2. The cell population is characterized in terms of daughter cells and mother cells. A daughter cell consumes substrate until it reaches a critical mass known as the transition mass. At this point, the daughter cell becomes a mother cell and a small bud attached to the cell begins to grow. Additional substrate

consumption increases the mass of the bud while the mass of the mother cell remains essentially constant. At a second critical mass known as the division mass, the bud separates from the mother cell producing a newborn daughter cell and a mother cell.

Many investigators have shown that continuous yeast cultures exhibit sustained oscillations under operating conditions encountered in industrial bioreactors (von Meyenburg, 1973; Parulekar et al., 1986). The intracellular mechanisms that cause these oscillations are controversial and have been a subject of three decades of intensive research. However, recent modeling and dynamical studies (Zhang et al., 2001) have established a strong dependence of the open-loop dynamics of yeast bioreactors on the initial cell mass *distribution*. Clearly, this dependence can only be captured (and accounted for in the controller design) by cell population balance models.

Furthermore, the existence of two distinct stages in yeast cultures (budded and unbudded) and the fact that key products of interest (such as ethanol) have been shown to be produced preferentially during the second part of the cell cycle (Alberghina et al., 1991; Frykman, 1999) suggest the use of two-staged population balance models for predicting and controlling the production of such products. This is also the case in other cell cultures, e.g. in murine hybridoma cells where the antibody secretion rates have been found to be much higher in the late stages of the cell cycle (Kromenaker and Sreenc, 1994). This type of information is simply not present in continuum models, whereas it can be naturally incorporated in multi-staged cell population balance models.

### Mathematical Formulation of Structured Cell Population Balance Models

In this section we briefly describe the mathematical formulation of cell population balance models in continuous bioreactors such as the one depicted in Figure 1. Each individual cell in the population of cells contained in the bioreactor is assumed to comprise of  $r$  biochemical components (DNA, RNA, protein etc.), with different cells containing different quantities of these components. The vector  $x = [x_1, x_2, \dots, x_r]$  with elements the amounts of these components in each cell is called the physiological state vector of the cell. The physiological state space is expressed as  $G = [x_{n,min}, x_{max}]$ , where  $x_{n,min}, x_{max}$  denote the vectors containing the minimum and maximum, respectively, values for the amounts of the  $r$  biomass components of the newborn cells. Finally,  $x_{min}$  denotes the vector containing the minimum values of the amounts of the  $r$  biomass components of the dividing cells. For the sake of simplicity and without loss of generality, it is often assumed that the minimum and maximum values of the quantities of all biomass components are  $x_{n,min} = x_{min} = 0$  and  $x_{max} = 1$ , respectively.

The state of the entire population is described by a

time-dependent function  $N(x, t)$ , such that  $N(x, t)dx$  represents the number of cells per unit of biovolume that at time  $t$  have physiological state representation between  $x$  and  $x + dx$ . The total number of cells per unit of biovolume (cell density) and the concentration of the  $i$ -th biomass component are respectively obtained from the zeroth and first moments of the state distribution function:

$$N_t(t) = \int_{x_{n,min}}^{x_{max}} N(x, t) dx \quad (1)$$

$$N_{b,i}(t) = \int_{x_{n,min}}^{x_{max}} x_i N(x, t) dx, \quad i = 1, \dots, r \quad (2)$$

The sum from 1 to  $r$  of all expressions defined in Equation 2 yields the total biomass concentration at time  $t$ . Finally,  $S$  denotes the substrate concentration vector (assuming  $s$  substrates),  $S_f$  the feed substrate concentration vector and  $D$  the dilution rate.

A cell population balance model includes information about nutrient uptake, growth, division and birth at the single-cell level. These processes are mathematically described by a set of functions known as intrinsic physiological state functions which, in general, depend on the physiological state of the cell  $x$  and the state of the substrate environment  $S$ . Specifically, the nutrient consumption is characterized by the  $s$ -dimensional consumption rate vector  $q(x, S)$  whose elements express the single-cell rate of consumption of each substrate. The growth process is represented by the  $r$ -dimensional growth rate vector  $r(x, S)$  whose elements express the single-cell rate of increase in the amount of the each cellular component. The cell division is described by the division rate  $\Gamma(x, S)$ . Finally, the birth process is described by the partition probability density function  $p(x, y, S)$ , which expresses the probability that a mother cell with physiological state vector  $y$  gives birth to a daughter cell with physiological state vector  $x$ ; this function must satisfy the normalization condition:

$$\int_{x_{min}}^{x_{max}} p(x, y, S) dx = 1 \quad (3)$$

which guarantees that it is a probability density function. It should also be such that the amount of each one of the  $r$  biochemical components is conserved at cell division. In particular, since no daughter cell can have greater amounts of any component than the dividing cell from which it originates, the partitioning function  $p$  should be zero for all daughter cell states that are greater than the states of the corresponding mother cell, i.e.:

$$p(x, y, S) = 0, \quad \forall x_i > y_i, \quad i = 1, \dots, r \quad (4)$$

Finally, the probability of a dividing cell with physiological state vector  $y$  to produce a daughter cell of state  $x$  must be equal to the probability of producing a daughter cell of state  $y - x$ , i.e.

$$p(x, y, S) = p(y - x, y, S) \quad (5)$$

For simplicity, it is also assumed that the bioreactor operates in conditions under which the cell death rate is negligible (quite common in practice).

**The Cell Population Balance Equation.** Under the assumptions and the process description presented above, the dynamics of the state distribution function  $N(x, t)$  are described by the general cell population balance equation (Fredrickson et al., 1967; Ramkrishna, 1979):

$$\begin{aligned} \frac{\partial N(x, t)}{\partial t} + \nabla_x \cdot [r(x, S)N(x, t)] \\ + \Gamma(x, S)N(x, t) + DN(x, t) \\ = 2 \int_x^{x_{max}} \Gamma(y, S)p(x, y, S)N(y, t) dy \quad (6) \end{aligned}$$

subject to the initial condition:

$$N(x, 0) = N_0(x) \quad (7)$$

The first term in Equation 6 denotes accumulation. The second term accounts for the loss of cells with the physiological state vector representation  $x$  due to the fact that they grow into bigger cells. The third term represents loss of cells with physiological state vector  $x$  due to division leading to the birth of smaller cells. The fourth term is the dilution term describing the rate by which cells exit the reactor. The source term in the right-hand side is the rate of birth of cells with the physiological state vector  $x$  originating from the division of all bigger cells. The integration in this term is performed in all  $r$  dimensions of the physiological state space and has a lower limit of  $x$  due to the fact that cells of physiological state  $x$  can not be born from cells with amounts of biochemical components less than  $x$ . Moreover, the factor of two multiplying the integral birth term accounts for the fact that each division event leads to the production of two daughter cells. For a detailed discussion on the statistical foundation of the above model and the detailed assumptions made for its derivation, the reader is referred to Fredrickson et al. (1967).

**Boundary Conditions.** Besides an initial condition, appropriate boundary conditions for the first order partial differential equation in Equation 6 are required. Defining the boundary  $B$  of the physiological state space  $G$  as the set of points where at least one of the  $r$  biochemical biomass components obtains either its maximum or minimum value, the boundary conditions can be mathematically expressed as (Eakman et al., 1966; Fredrickson et al., 1967):

$$r(x, S)N(x, t) = 0, \quad \forall x \in B \quad (8)$$

These conditions (often referred to as regularity conditions), essentially specify the boundary of the physiological state space (and hence can be more accurately

thought of as 'containment' conditions (Fredrickson and Mantzaris, 2002)) and have been the subject of considerable discussion in the literature. They can be derived from balances for the cell density and the concentrations of the biomass components (see e.g. Mantzaris et al., 2001a), and essentially force the solution of the cell population balance equation to satisfy two facts imposed by the physics of the problem: a) that cell growth does not affect the number of cells, and b) that cell division preserves biomass.

**The Dynamics of the Substrate Concentrations.** The cell population balance equation is coupled with the equations describing the dynamics of the substrate concentrations:

$$\frac{dS}{dt} = D(S_f - S) - \int_{x_{n, min}}^{x_{max}} q(x, S)N(x, t) dx \quad (9)$$

subject to the initial conditions:

$$S(0) = S_0 \quad (10)$$

The integral term in the above mass balance represents the rate of loss of substrate leading to cell growth. In the case where a single rate limiting substrate is present the above set of equations reduces to a single equation.

Notice that the coupling between the cell population balance equation and the ordinary integro-differential equations shown above occurs through the dependence of the intrinsic physiological state functions on the concentrations of the substrates. This coupling is the only source of nonlinearity in the model. If the assumption of constant substrate concentrations is made (not a reasonable one in most cases of practical interest), then the model consists only of the cell population balance model and is linear.

#### Unstructured Cell Population Balance Models.

A common simplification to the general structured cell population balance model presented above concerns the case of a single physiological state  $x$ , usually the cell mass  $m$ ; this is quite meaningful in bioreactors where cell growth and division are strongly dependent on cell mass. In this case, the growth rate vector becomes a scalar and the resulting unstructured cell population model takes the form:

$$\begin{aligned} \frac{\partial N(m, t)}{\partial t} + \frac{\partial [r(m, S)N(m, t)]}{\partial m} \\ + \Gamma(m, S)N(m, t) + DN(m, t) \\ = 2 \int_m^{m_{max}} \Gamma(m', S)p(m, m', S)N(m', t) dm' \quad (11) \end{aligned}$$

with the integral in the birth term being a one-dimensional one, and the mass state space defined as  $M = [0, m_{max}]$ . The containment boundary conditions take the form:

$$r(0, S)N(0, t) = r(m_{max}, S)N(m_{max}, t) = 0 \quad (12)$$

and the substrate balance equations become:

$$\frac{dS}{dt} = D(S_f - S) - \int_0^{m_{max}} q(m, S)N(m, t) dm \quad (13)$$

#### Multi-Stage Cell Population Balance Models.

Consider now the case where the cells grow in two distinct stages (e.g. budded and unbudded in the case of yeast), with stage 1 cells being born through the division of stage 2 cells, and stage 2 cells being formed through the transition of stage 1 cells to stage 2. Let  $N_1(x, t)dx$  and  $N_2(x, t)dx$  denote the number of cells per unit of biovolume in stages 1 and 2, respectively, which at time  $t$  have physiological state between  $x$  and  $x + dx$ . Let also  $r_1(x, S), r_2(x, S)$  denote the corresponding growth rate vectors,  $\Gamma_1(x, S), \Gamma_2(x, S)$  the transition rates from stage 1 to stage 2 and from stage 2 to stage 1, respectively, and  $p(x, y, S)$  the partition probability density function. Then, the dynamics of the two subpopulations are described by the following coupled set of cell population balance equations:

$$\begin{aligned} \frac{\partial N_1(x, t)}{\partial t} + \nabla_x \cdot [r_1(x, S)N_1(x, t)] \\ + \Gamma_1(x, S)N_1(x, t) + DN_1(x, t) \\ = 2 \int_x^{x_{max}} \Gamma_2(y, S)p(x, y, S)N_2(y, t) dy \quad (14) \end{aligned}$$

$$\begin{aligned} \frac{\partial N_2(x, t)}{\partial t} + \nabla_x \cdot [r_2(x, S)N_2(x, t)] \\ + \Gamma_2(x, S)N_2(x, t) + DN_2(x, t) \\ = \Gamma_1(x, S)N_1(x, t) \quad (15) \end{aligned}$$

Note that the above equations are coupled through their corresponding source terms appearing in the right-hand sides.

The balances on the substrates in this case take the form:

$$\begin{aligned} \frac{dS}{dt} = D(S_f - S) - \int_{x_{n, min}}^{x_{max}} q_1(x, S)N_1(x, t) dx \\ - \int_{x_{n, min}}^{x_{max}} q_2(x, S)N_2(x, t) dx \quad (16) \end{aligned}$$

where  $q_1(x, S), q_2(x, S)$  denote the corresponding substrate consumption rates in the two stages. Appropriate initial and containment boundary conditions (see e.g. Mantzaris et al., 2002) complete the model formulation. The incorporation of multiple cell cycle stages in the mathematical model can also be performed in a similar way (Hatzis et al., 1995).

#### Numerical Solution

Despite the generality, accuracy, and predictive power of cell population balance models, and the fact that they

have been formulated since the mid 60s, their use for design, optimization and control of bioprocesses has been sparse. One major obstacle to this end is that cell population balance models require information at the single-cell level; in particular, they require the knowledge of the intrinsic physiological state functions (single-cell growth rates, single-cell stage-to-stage transition rates and partitioning function). The experimental determination of these functions is hard, mainly due to the fact that it requires measurements at the single-cell level. However, the evolution of flow cytometry (Srienc, 1993) has contributed significantly in providing a basis for obtaining information at the single cell level. The analysis of such information with inverse population balance modeling techniques (Ramkrishna, 1994) has enabled, in certain cases, the determination of the intrinsic physiological state functions (Srienc, 1999).

A second obstacle towards the practical application of cell population balance models is the fact that owing to their complex mathematical nature (first order partial integro-differential equations, coupled in a nonlinear fashion with ordinary integro-differential equations), the development of numerical algorithms for the accurate approximation of their solution is a challenging task.

Several studies have addressed the numerical solution of age structured cell population balances (Hjortso and Bailey, 1983; Hjortso and Nielsen, 1994, 1995; Kim, 1996; Kim and Park, 1995a,b; Kostova, 1990, 1988; Kurtz et al., 1998). However, age structured models are limited by the fact that age is very difficult to measure experimentally in microbial populations.

On the other hand, some properties of cells, such as volume, total protein content, DNA content can be measured even at the single-cell level. Therefore, the use of such properties in the formulation of mass structured models is quite meaningful. Liou et al. (1997) developed analytical solutions of mass structured and age-mass structured cell population balances in the case of some simple single-cell growth rate expressions. Reports on the numerical solution of more general mass structured models had been sparse until recently. Subramanian and Ramkrishna (1971) employed a combination of the weighted residual method and the successive approximation method. However, this approach is limited to the case of linear growth rate where the cell population balance and the substrate concentration equation can be decoupled. Sulsky (1994) addressed a specific nonlinear mass structured population balance model, with the use of classical finite difference schemes as well as the method of characteristics. However, the model under consideration did not include changes in the environmental conditions, which when incorporated in the mathematical formulation can dramatically alter the dynamics of the cell population as well as the behavior of numerical schemes. Godin et al. (1999a,b) and Zhu et al. (2000; 2001) employed finite element techniques for the solution of the

problem under conditions of changing substrate concentration. Finally, Mantzaris et al. (1999) proposed a finite difference technique applicable to problems with changing substrate concentration and various sets of physiological state functions.

The above reports focused on unstructured models, which do not incorporate any internal chemical structure of the single cell. Mantzaris et al. (2001a,b,c) have recently developed several finite difference, spectral and finite element algorithms for the solution of structured cell population balance models, and evaluated these algorithms in terms of numerical stability, accuracy and computational speed. These algorithms are quite general in the sense that they are not limited by the choice of the physiological state functions, and can be applied for any number of substrates and constant or changing environmental conditions. With small modifications, they can also be applied in the case of multi-staged cell population balance models (Mantzaris et al., 2002).

In conclusion, the recent studies on the numerical solution of cell population balance models have led to a variety of algorithms that can be used to efficiently obtain accurate solutions of these models and hence facilitate their use in optimization and control.

## Cell Population Dynamics

The dynamics of continuous bioreactors are important for simulation and control of industrial bioprocesses. Bioreactors can exhibit complex dynamic behavior due to nonlinearities associated with cell growth and division processes. Unlike most other types of chemical reactors, these nonlinear dynamics are not caused by the nonlinear dependence of reaction rates on temperature. Indeed continuous bioreactors operated at constant temperature can exhibit nonlinear behavior such as multiple steady states and limit cycles (Hjortso and Bailey, 1983; Hjortso and Nielsen, 1995). While cell metabolism certainly plays an important role, the observed nonlinear behavior is partially attributable to complex interactions between the cell population and the culture environment (Eakman et al., 1966; Subramanian and Ramkrishna, 1971). Consequently the study of cell population dynamics has considerable theoretical and practical significance. The objective of this section is to provide a brief introduction to the control relevant dynamics of cell population models with particular emphasis on limit cycle behavior in continuous yeast bioreactors.

### Steady-State and Periodic Solutions

A rigorous dynamic analysis of the general cell population model (6)–(10) is very difficult due to the complexity of the model equations. The problem can be simplified by considering only a single physiological state ( $x$ ) and a single rate limiting substrate ( $S$ ). In this case the unstructured cell population model can be written as

in (11)–(13). It is well known that this model can exhibit both steady-state and periodic solutions for specific forms of the physiological state functions.

The first problem considered is existence and stability of steady-state solutions. As can be seen from (11)–(13), a solution that exists for all values of dilution rate ( $D$ ) and feed substrate concentration ( $S_f$ ) is the so-called washout steady state:  $N(m) = 0 \forall m, S = S_f$ . This corresponds to the highly undesirable situation where substrate is fed to the reactor but biomass is not produced. Stability of the washout steady state usually can be characterized in terms of a critical dilution rate ( $D_c$ ) that is a complex function of the physiological state functions and parameter values. For  $D < D_c$  the washout steady state is unstable while for  $D \geq D_c$  it is stable. Hence there is a tradeoff between reactor stability (low  $D$ ) and reactor throughput (high  $D$ ). Clearly the most important requirement of any bioreactor control system is to avoid washout and maintain bioreactor productivity.

Non-trivial steady-state solutions of cell population models are more difficult to analyze. Closed-form solutions can be obtained using the method of characteristics if restrictive assumptions are imposed on the cell cycle and/or the culture environment (Hjortso, 1996; Hjortso and Nielsen, 1995). This approach has been used to analyze local stability of steady-state solutions for an age structured cell population model (Hjortso and Bailey, 1983). A more practical approach for local stability analysis involves spatial discretization of the cell population model to obtain a coupled set of nonlinear ordinary differential equations in time (Zhang et al., 2001). Steady-state solutions are calculated by solving the nonlinear algebraic equations which comprise the steady-state version of the discretized model. Local stability of a steady-state solution is analyzed by linearizing the discretized model about the steady-state operating point and computing the eigenvalues of the linearized model. Non-local stability analysis typically requires dynamic simulation of the discretized model. A secondary control objective may be stabilization of a particular cell mass distribution  $N(m)$  that optimizes the steady-state production of certain products.

Experimental studies with different microorganisms have shown that continuous bioreactors can exhibit stable periodic solutions which are observable as sustained oscillations in measured variables (Daugulis et al., 1997; Jones, 1995; von Meyenburg, 1973). Several investigators have shown that cell population models are capable of generating such periodic solutions (Bellgardt, 1994; Hjortso and Nielsen, 1995; Zhu et al., 2000). Closed-form representation of periodic solutions have been derived directly from cell population models under certain simplifying assumptions (Hjortso and Nielsen, 1995). We are not aware of any analysis results concerning the stability of such periodic solutions. As discussed below for yeast bioreactors, periodic solutions usually are located

by dynamic simulation of a spatially discretized model. Another possible control objective is creation of periodic solutions that lead to increased production of certain products as compared to that achievable under steady-state conditions (Hjortso, 1996).

### Dynamics of Continuous Yeast Bioreactors

Cell population dynamics play a key role in the sustained oscillations observed in continuous bioreactors producing Baker's yeast. Fundamental understanding of these dynamics could lead to important advances in yeast production processes and provide key insights into the cellular behavior of more complex cells present in plants and animals. Several investigators (Munch et al., 1992; Strassle et al., 1989) have shown that the appearance of sustained oscillations is related to the formation of distinct cell subpopulations via a mechanism known as cell cycle synchrony. A synchronized culture is recognized by well defined peaks in the cell distribution that correspond to large groups of cells that collectively pass through the cell cycle.

Recently it has been proposed that continuous yeast bioreactors can exhibit a stable steady state and a stable limit cycle at the same operating conditions as a consequence of cell cycle synchrony (Zhang et al., 2001). Experimental data that support this claim are shown in Figure 3 where the carbon dioxide off-gas concentration is used as a representative output signal. The experimental protocol used involves careful manipulation of the dilution rate to establish different initial conditions for the cell distribution. An initial condition corresponding to a synchronized cell population results in convergence to a stable limit cycle (top plot). By contrast, a steady-state solution appears to be attained when the initial cell population is less synchronized (bottom plot).

The experimental data in Figure 3 show that the open-loop dynamics of yeast bioreactors are strongly dependent on the initial condition of the cell distribution. At a particular value of the dilution rate there appears to be two stable solutions, each with a domain of attraction that is a complex function of the initial cell distribution. This interpretation provides a rational explanation for the observation that oscillations appear and disappear without measurable changes in external inputs such as dilution rate and feed substrate concentration (Parulekar et al., 1986). Moreover this nonlinear behavior would be fundamentally different than that observed in other particulate processes such as emulsion polymerization reactors (Rawlings and Ray, 1987) and solution crystallizers (Witkowski and Rawlings, 1987) that exhibit sustained oscillations as the steady-state solution becomes unstable.

A more detailed understanding of the nonlinear dynamics leading to sustained oscillations can be obtained via bifurcation analysis (Kuznetsov, 1995). A bifurcation represents a fundamental change in the qualitative

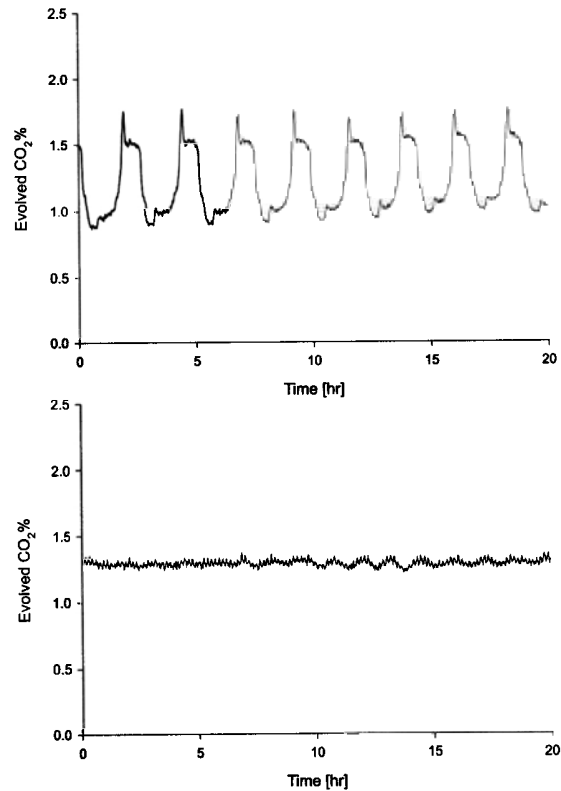

Figure 3: Multiple stable solutions for a yeast bioreactor.

behavior of a nonlinear system as a parameter is varied. The most common example is the Hopf bifurcation where the steady state becomes unstable and a stable limit cycle is created (Kuznetsov, 1995).

We have performed bifurcation analysis using the unstructured cell population model (11)–(13) with specific forms of the physiological state functions (Zhang et al., 2001). The single cell growth rate is modeled as:

$$r(m, S') = \frac{\mu_m S'}{K_m + S'} \quad (17)$$

where  $\mu_m$  and  $K_m$  are constants. The effective substrate concentration  $S'$  is a filtered version of the actual substrate concentration ( $S$ ) and accounts for the lagged response of cells to environmental changes. The growth rate function models the tendency of cells to reach a maximum growth rate ( $\mu_m$ ) at large substrate concentrations (substrate inhibition). The division rate function is modeled as:

$$\Gamma(m, S') = \begin{cases} 0 & m \leq m_t^* + m_o \\ \gamma \exp[-\epsilon(m - m_d^*)^2] & m \in [m_t^* + m_o, m_d^*] \\ \gamma & m \geq m_d^* \end{cases} \quad (18)$$

where  $m_t^*$  is the transition mass (see Figure 2),  $m_o$  is the



additional mass that mother cells must gain before division is possible,  $\epsilon$  and  $\gamma$  are constants and  $m_d^*$  is the mass at which the division rate reaches its maximum value  $\gamma$ . This function models the tendency of cells to divide near the division mass ( $m_d^*$ ). The cell cycle parameters ( $m_t^*$ ,  $m_d^*$ ) are functions of  $S'$  as discussed below.

The partition probability density function has the form:

$$p(m, m', S') = A \exp[-\beta(m - m_t^*)^2] + A \exp[-\beta(m - m' + m_t^*)^2] \quad (19)$$

where  $m < m'$  and  $m' > m_t^* + m_o$ ; the function is identically zero otherwise. Here  $A$  and  $\beta$  are constants. This function yields two Gaussian peaks in the cell mass distribution, one centered at  $m_t^*$  (corresponding to mother cells) and one centered at a location in the mass domain that is determined by mass conservation (corresponding to daughter cells). The substrate consumption rate is modeled as:

$$q(m, S') = \frac{1}{Y} r(m, S') \quad (20)$$

where  $Y$  is a constant yield parameter. The substrate dependence of the cell cycle parameters is modeled as:

$$m_t^*(S') = \begin{cases} m_{t0} + K_t(S_l - S_h) & S' < S_l \\ m_{t0} + K_t(S' - S_h) & S' \in [S_l, S_h] \\ m_{t0} & S' > S_h \end{cases} \quad (21)$$

$$m_d^*(S') = \begin{cases} m_{d0} + K_d(S_l - S_h) & S' < S_l \\ m_{d0} + K_d(S' - S_h) & S' \in [S_l, S_h] \\ m_{d0} & S' > S_h \end{cases} \quad (22)$$

where  $S_l$ ,  $S_h$ ,  $m_{t0}$ ,  $m_{d0}$ ,  $K_t$  and  $K_d$  are constants. As found experimentally (Alberghina et al., 1991), both  $m_t^*$  and  $m_d^*$  are increasing functions of the substrate concentration. Numerical values of the model parameters are presented elsewhere (Zhang et al., 2001).

The dilution rate ( $D$ ) is chosen as the bifurcation parameter. Stability of steady-state solutions is determined by checking the eigenvalues of the Jacobian linearization. Stable limit cycles are located using a combination of dynamic simulation and continuation calculations (Kuznetsov, 1995). The resulting bifurcation diagram is shown in Figure 4 where the zeroth moment of the cell mass distribution (here denoted as  $m_0$ ) is used as a representative output variable. As observed experimentally (Beuse et al., 1998), a stable steady state (+) is obtained for low and high ranges of the dilution rate. A Hopf bifurcation occurs at  $D = 0.21 \text{ h}^{-1}$  that results in the appearance of a stable limit cycle with sustained oscillations of the magnitude indicated (\*). A second Hopf bifurcation occurs at  $D = 0.27 \text{ h}^{-1}$  where the limit cycle disappears. An unstable steady state (o) is observed at the intermediate dilution rates that support stable limit cycles.

The bifurcation diagram appears to be inconsistent with the experimental data in Figure 3 which indicate the

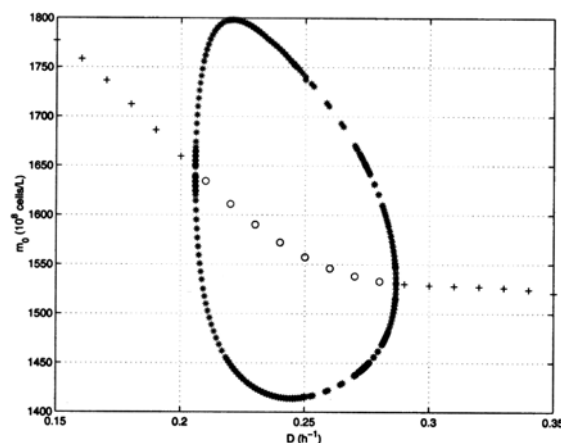

Figure 4: Bifurcation diagram for a yeast bioreactor model.

coexistence of stable steady state and stable periodic solutions. However the model predicts that destabilization of the steady state occurs very slowly due to the small real parts of the eigenvalues that cross the imaginary axis due to the first Hopf bifurcation. We conjecture that this behavior is not observed in Figure 3 due to the relatively short duration of the experimental test. This hypothesis is supported by the small oscillations that are visible in the “stationary” response. This subtle dynamic behavior cannot be captured by unsegregated models such as cybernetic models (Jones and Kompala, 1999).

## Feedback Control of Cell Populations

Feedback control is necessary to ensure satisfactory performance of continuous bioreactors in the presence of external disturbances and/or changes in the operational requirements. As depicted in Figure 1, a typical bioreactor control system consists of simple regulatory loops for residence time, temperature and pH designed to maintain the bioreactor at environmental conditions which promote cell growth. Such simple schemes do not allow direct control of variables such as the biomass concentration that determine profitability of the bioprocess. During the last decade substantial effort has gone into developing more advanced (nonlinear or adaptive) control strategies for continuous bioreactors (Bastin and Dochain, 1990; Hoo and Kantor, 1986; El Moubaraki et al., 1993; Pons, 1992; Kurtz et al., 2000). These efforts are based on continuum models that neglect the distributed nature of the cell population. As such, they rely on measurement and control of ‘average’ properties of the cell populations in the bioreactor. A typical control strategy along these lines involves manipulation of the dilution rate or the feed substrate concentration to maximize biomass concentration (Henson and Seborg, 1992; Proll and Karim, 1994).

The last decade has also seen the evolution of experimental techniques, specifically flow cytometry and cell staining techniques (Srienc, 1993), which enable the measurement of entire cell property distributions. Flow cytometers measure the frequency of fluorescence in the cell population, and hence can differentiate cells with respect to naturally fluorescent protein content (e.g. the green fluorescent protein, Gfp), or other variables (e.g. DNA content) after appropriate staining. When interfaced with proper flow injection systems (Zhao et al., 1999) they provide a powerful experimental tool for on-line monitoring and control. These advances in instrumentation and measuring devices, together with the advances in the numerical solution of cell population balance models outlined earlier, provide strong motivation to explore more advanced control strategies that utilize cell population balance models to address a wider range of control objectives, e.g. control of cell property distributions and/or cell cycle characteristics.

This realization has motivated research in our groups on the development of control strategies based on cell mass population balance models that address a variety of control objectives. Specifically, in Zhang et al. (2001) the problem of attenuating open-loop oscillations observed in yeast bioreactors was addressed, through the design of a feedback linearizing controller that manipulates the dilution rate and controls the zeroth moment of the cell mass distribution. The design of distributed feedback linearizing control laws that manipulate the dilution rate to influence the zeroth and first moment of cell mass distributions was also addressed in Mantzaris et al. (1998). Zhu et al. (2000) addressed the attenuation of oscillations as well as the induction of oscillations in yeast bioreactors, using a linear model predictive control strategy that manipulates the dilution rate and the feed substrate concentration. Finally, Mantzaris et al. (1999) addressed the productivity control for a cell culture where the desired product is produced only in the second stage of the cell cycle, using a feedback linearizing control strategy that manipulates the feed substrate concentration. In what follows, we briefly outline the last two control studies in order to demonstrate the potential advantages of using cell population models as the basis for controller design. More details on the controller design and additional simulation results are available in the original references.

### Oscillation Attenuation in Yeast Bioreactors

The first case study addresses the control of oscillations in continuous yeast bioreactors. The motivation is provided by the fact that open-loop oscillations can adversely affect bioreactor stability and productivity, in which case it is imperative that they be attenuated. In other cases, inducing stable oscillatory behavior may lead to increased production of target metabolites preferentially produced during part of the cell cycle (Hjortso,

1996). Below we outline a linear model predictive control (LMPC) strategy which is well suited for both of the above control problems.

The controller design model is generated from the cell population model (11)–(13) and the physiological state functions (17)–(20). The population model is discretized in the mass domain using orthogonal collocation on finite elements, linearized about the desired steady-state operating point and discretized with a sampling time  $\Delta t = 0.1$  hr. The resulting linear model has the form:

$$x(k+1) = Ax(k) + Bu(k) \quad (23)$$

where:  $x$  is the state vector which includes the cell mass density  $N_j$  at each collocation point  $j$  and the substrate concentration  $S$ ; and  $u$  is the input vector comprised of the dilution rate  $D$  and feed substrate concentration  $S_f$ . It is assumed that the cell mass distribution can be measured via flow cytometry or reconstructed from on-line measurements of the particle size distribution (Yamashit et al., 1993).

The controller design model is completed by defining the output vector. An obvious approach is to choose the discretized cell mass densities  $N_j$  as the controlled outputs. This method is problematic because: (i) the resulting control problem is highly non-square (2 inputs, 113 outputs); (ii) cell mass densities at nearby collocation points are strongly collinear; and (iii) the substrate concentration must be controlled to avoid washout. We have found that good closed-loop performance can be obtained by controlling a subset of the cell mass densities and the substrate concentration:

$$y(k) = [N_{j_1}(k) \ \dots \ N_{j_p}(k) \ S(k)]^T = Cx(k) \quad (24)$$

where the indices  $\{j_1, \dots, j_p\}$  denote the collocation points where the associated cell mass density is used as a controlled output. In the subsequent simulations, the outputs are chosen as the boundary points of the finite elements. This results in a much lower dimensional problem with 14 outputs.

The LMPC controller is formulated as an infinite horizon open-loop optimal control problem:

$$\begin{aligned} \min_{U_M(k)} \sum_{j=0}^{\infty} \{ & [y(k+j|k) - y_s]^T Q [y(k+j|k) - y_s] \\ & + [u(k+j|k) - u_s]^T R [u(k+j|k) - u_s] \\ & + \Delta u^T(k+j|k) S \Delta u(k+j|k) \} \quad (25) \end{aligned}$$

where:  $y(k+j|k)$  and  $u(k+j|k)$  are predicted values of the outputs and inputs, respectively;  $y_s$  and  $u_s$  are target values for the outputs and inputs, respectively; and  $\Delta u(k) = u(k) - u(k-1)$ . The decision variables are current and future values of the inputs:  $U_M(k) = [u(k|k) \ \dots \ u(k+M-1|k)]$ , where  $M$  is the control horizon. The inputs are subject to constraints that are determined by operational limitations:  $u_{min} \leq u \leq u_{max}$ .

The resulting problem can be reformulated as a finite horizon problem and solved using standard quadratic programming software (Muske and Rawlings, 1993). The control horizon is chosen as  $M = 5$  and the weighting matrices ( $Q$ ,  $R$ ,  $S$ ) are chosen by trial-and-error to provide acceptable closed-loop performance.

Figure 5 shows the ability of the LMPC controller to stabilize an oscillating bioreactor at a desired steady-state operating point. The zeroth-order moment of the cell mass distribution and the substrate concentration ( $S$ ) are shown as representative output variables. The initial cell mass distribution  $N(m, 0)$  corresponds to a stable periodic solution, while the setpoint vector is obtained from the discretized cell mass distribution at the desired steady-state operating point. The solid line is the LMPC response and the dashed line is the open-loop response in the absence of feedback control. The LMPC controller effectively attenuates the oscillations while generating reasonable control actions. The evolution of the cell mass distribution (here denoted as  $W$ ) also is shown in Figure 5. The initial distribution is highly synchronized with two cell subpopulations that produce sustained oscillations. The controller achieves the desired steady-state distribution by dispersing the subpopulations.

Figure 6 shows the ability of the LMPC controller to create a desired periodic solution. The initial mass number distribution corresponds to the steady-state solution in Figure 5. The stable periodic solution shown as the open-loop response in Figure 5 is used to define a time-varying setpoint trajectory to be tracked. The controller stabilizes the periodic solution by generating oscillatory input moves. Although not shown, it is interesting to note that the oscillations are sustained with the same period when the controller is switched off at the end of the simulation and the bioreactor runs under open-loop conditions. The evolution of the cell mass distribution also is shown in Figure 6. Note that the oscillating dynamics are accompanied by the appearance of two distinct cell subpopulations. These results suggest that feedback control strategies which provide direct control of the cell distribution have the potential to enhance the stability and productivity of continuous yeast bioreactors.

### Productivity Control in Two-staged Cell Growth

In the second case study, we address the problem of controlling the productivity with respect to a desired product in a continuous bioreactor where the cells grow in two stages, with the desired product being formed only in the second stage (this is consistent with the discussion in page 4 on the behavior of many microorganisms including yeast). Individual cells are differentiated with respect to their mass,  $m$  (or any other variable that is conserved). There is a single substrate with concentration  $S$ , whereas the product concentration is denoted by  $P$ .

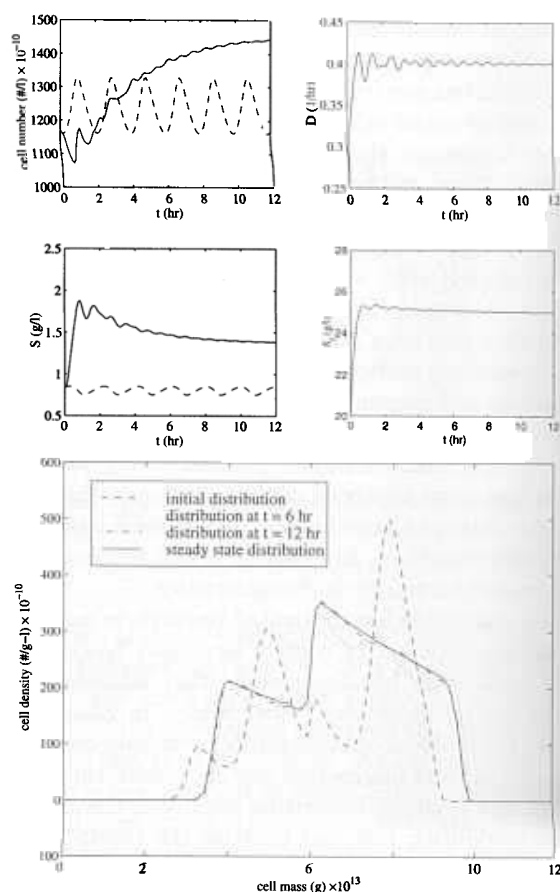

Figure 5: Oscillation attenuation with LMPC control.

It is assumed that the single-cell growth rates are linear with respect to cell mass and exhibit substrate inhibition during both stages of the cell cycle, whereas during the second stage the growth rate exhibits product inhibition as well (this is a rather standard assumption, see e.g. Henson and Seborg, 1992). Specifically, the single-cell growth rates are expressed as:

$$r_1(m, S) = \frac{\mu_m S}{K_m + S + \frac{S^2}{K_i}} m \quad (26)$$

$$r_2(m, S, P) = \frac{\mu_m \left(1 - \frac{P}{P_m}\right) S}{K_m + S + \frac{S^2}{K_i}} m \quad (27)$$

where  $\mu_m$ ,  $P_m$ ,  $K_m$ ,  $K_i$  are the maximum specific growth rate, the product and substrate saturation constants and the substrate inhibition constant, respectively.

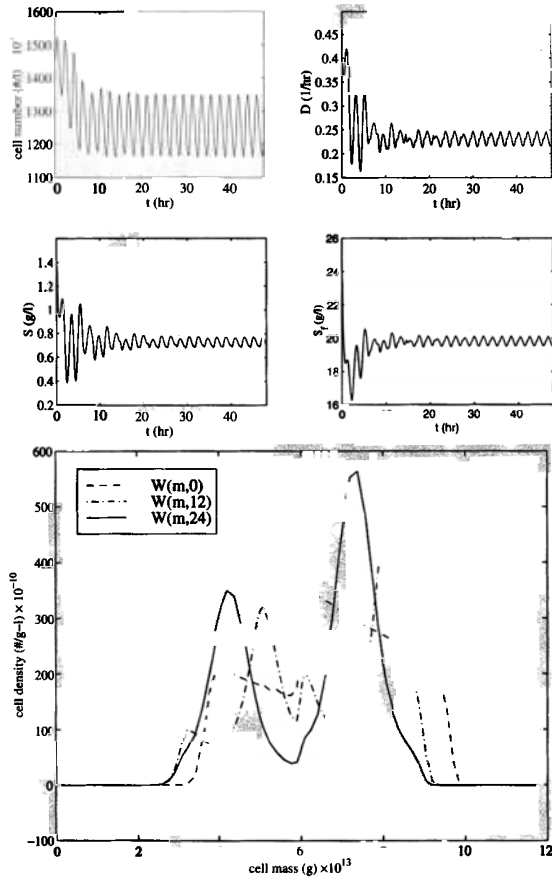

Figure 6: Oscillation stabilization with LMPC control.

The transition rates from stage 1 to stage 2, and from stage 2 to stage 1 are modeled as follows (Fredrickson et al., 1967):

$$\Gamma_1(m, S) = \frac{f_1(m)}{1 - \int_0^m f_1(m') dm'} r_1(m, S) \quad (28)$$

$$\Gamma_2(m, S, P) = \frac{f_2(m)}{1 - \int_0^m f_2(m') dm'} r_2(m, S, P) \quad (29)$$

where  $f_1(m)$ ,  $f_2(m)$  are the transition probability density functions which are assumed to depend only on mass; these functions are taken to be Gaussian distributions with mean values  $\mu_{f_1}$ ,  $\mu_{f_2}$  and standard deviations  $\sigma_{f_1}$ ,  $\sigma_{f_2}$ , respectively.

The partitioning function is assumed to be independent of the substrate and product concentrations, and is taken to be a symmetric beta distribution with a parameter  $q$ :

$$p(m, m') = \frac{1}{B(q, q)} \frac{1}{m'} \left(\frac{m}{m'}\right)^{q-1} \left(1 - \frac{m}{m'}\right)^{q-1} \quad (30)$$

The substrate consumption rates during the two stages

of the cell cycle are expressed as:

$$q_1(m, S) = \frac{1}{Y_1} r_1(m, S)$$

$$q_2(m, S, P) = \frac{1}{Y_2} r_2(m, S, P)$$

where  $Y_1, Y_2$  denote constant yield coefficients. Finally, the product formation rate is expressed as:

$$r_p(m, S, P) = a(\mu_2(S, P) + b)m$$

where  $a, b$  are constants. The parameter values used can be found in Mantzaris et al. (1999).

The dynamic model of the reactor consists of the two cell population balance equations for stages 1 and 2, the substrate balance and the product balance:

$$\begin{aligned} \frac{\partial N_1(m, t)}{\partial t} + \frac{\partial [r_1(m, S) N_1(m, t)]}{\partial m} \\ + \Gamma_1(m, S) N_1(m, t) + D N_1(m, t) \\ = 2 \int_0^{m_{max}} \Gamma_2(m, S, P) p(m, m', S) N_2(m, t) dm' \\ \frac{\partial N_2(m, t)}{\partial t} + \frac{\partial [r_2(m, S, P) N_2(m, t)]}{\partial m} \\ + \Gamma_2(m, S, P) N_2(m, t) + D N_2(m, t) \\ = \Gamma_1(m, S, P) N_1(m, t) \end{aligned} \quad (35)$$

$$\begin{aligned} \frac{dS}{dt} = D(S_f - S) - \frac{1}{Y_1} \int_0^{m_{max}} r_1(m, S) N_1(m, t) dm \\ - \frac{1}{Y_2} \int_0^{m_{max}} r_2(m, S, P) N_2(m, t) dm \end{aligned}$$

$$\frac{dP}{dt} = -DP + \int_0^{m_{max}} r_p(m, S, P) N_2(m, t) dm \quad (37)$$

with the following boundary conditions for the two population balance equations (see Mantzaris et al., 1999, for their derivation):

$$\begin{aligned} \int_0^{m_{max}} \frac{\partial [r_1(m, S) N_1(m, t)]}{\partial m} dm = 0 \\ \int_0^{m_{max}} \frac{\partial [r_2(m, S, P) N_2(m, t)]}{\partial m} dm = 0 \end{aligned}$$

For the numerical solution and controller design, the two cell population balance equations were discretized in the mass space using a Galerkin spectral method. Specifically, the stage 1 and 2 mass distributions were expanded as follows:

$$\begin{aligned} N_1(m, t) = \sum_{i=1}^{\infty} a_i(t) \phi_i(m) \\ N_2(m, t) = \sum_{i=1}^{\infty} b_i(t) \phi_i(m) \end{aligned} \quad (40)$$

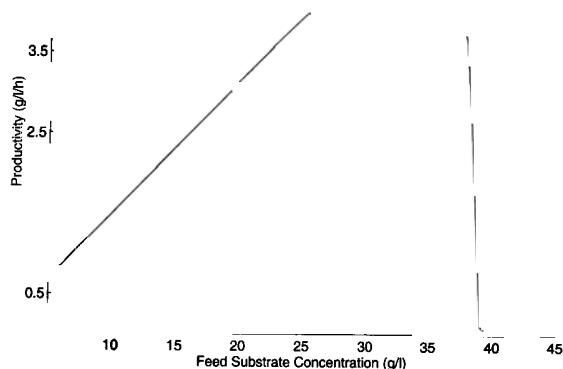

Figure 7: Steady state productivity vs. feed substrate concentration.

where  $\phi_i = \sqrt{2}\sin(i\pi m)$  and  $a_i, b_i$  denote the time dependent coefficients of the sine expansions (it can be easily verified that with these basis functions the boundary conditions are satisfied). Following the usual procedure of substituting the expansions to the partial differential equations and taking the inner product with the adjoint functions, an infinite set of ODEs for the time varying coefficients can be obtained. To obtain a finite-dimensional approximation of the infinite dimensional model, the infinite series expansion was truncated to include  $n = 20$  terms.

**Open-loop Behavior.** Initially, the effect of the dilution rate  $D$  and the feed substrate concentration  $S_f$  on the steady state productivity  $DP$  was analyzed. The analysis established that there is a pair of these operating parameters,  $D = 0.18h^{-1}$  and  $S_f = 34g/l$ , where the productivity is maximized (the maximum is approximately  $DP_{max} = 4.93g/l/h$ ). Figure 7 shows a plot of the productivity as a function of the feed substrate concentration at steady state, for  $D = 0.18h^{-1}$ . The occurrence of a maximum in the productivity is consistent with the results obtained in Henson and Seborg (1992) which considered a continuum model consisting of biomass, substrate and product balances, with the same functions and parameters for cell growth, substrate consumption and product formation. This behavior is also indicative of the nonlinearity of the system and motivates the design of nonlinear controllers to maintain the productivity close to its maximum.

**Nonlinear Productivity Control.** The control study focused on controlling the productivity  $y = DP$  close to its maximum value  $y_{sp} = 4.93g/l/h$  using the feed substrate concentration  $S_f$  as manipulated input. The dilution rate was fixed at  $D = 0.18h^{-1}$ , and hence the control strategy essentially aimed at maximizing the

model was used as the basis for the controller design. Specifically, the relative degree of this model was found to be two, as long as the reactor operates away from washout conditions and from a manifold which intersects the equilibrium curve of Figure 7 approximately at the maximum productivity (note that due to the complexity of the model one has to rely on numerical approximations for the above observations). Also, the zero dynamics with respect to the output variable was numerically found to be locally asymptotically stable at the setpoint conditions.

A nonlinear state feedback controller was designed that induces the following linear response in the closed-loop system:

$$\gamma_2 \frac{d^2 y}{dt^2} + \gamma_1 \frac{dy}{dt} + y = y_{sp} \quad (41)$$

For comparison purposes, the approximate finite dimensional model was also linearized (around the steady state conditions corresponding to the setpoint), and a linear state feedback controller was designed on the basis of the resulting linear model to enforce the same behavior as above.

Figure 8 shows the results of a representative simulation run for  $\gamma_1 = \gamma_2 = 10$ . The initial cell mass distributions in the two stages, and the substrate and product concentrations were obtained from the steady state corresponding to  $S_f = 25g/l$ . The corresponding initial productivity was  $y = 3.95g/l/h$ , which is approximately 20% smaller than the setpoint value. Notice that the nonlinear controller induces the desired closed-loop response and smoothly brings the system to the desired setpoint. On the other hand, the output response under the linear controller is considerably more sluggish, taking almost twice as long to bring the productivity to its setpoint. Further, the manipulated input for the linear controller exhibits a much larger peak in the initial part of the response. For larger deviations from the setpoint, the linear controller led to closed-loop instability, whereas the nonlinear controller continued to perform very satisfactorily (successful results were obtained with the initial productivity being as much as seven times smaller than the maximum productivity).

A second simulation run addressed the disturbance rejection properties of the two controllers. Specifically, the actual value of the maximum specific growth rate was assumed to be approximately 10% smaller than the nominal one. The productivity setpoint was chosen as  $y_{sp} = 4.43g/l/h$  which corresponds to the approximate maximum productivity for the actual value of the maximum specific growth rate. Integral action was incorporated in both controllers. Figure 9 shows the controlled output and manipulated input responses. The nonlinear controller exhibits again a faster response, with smaller

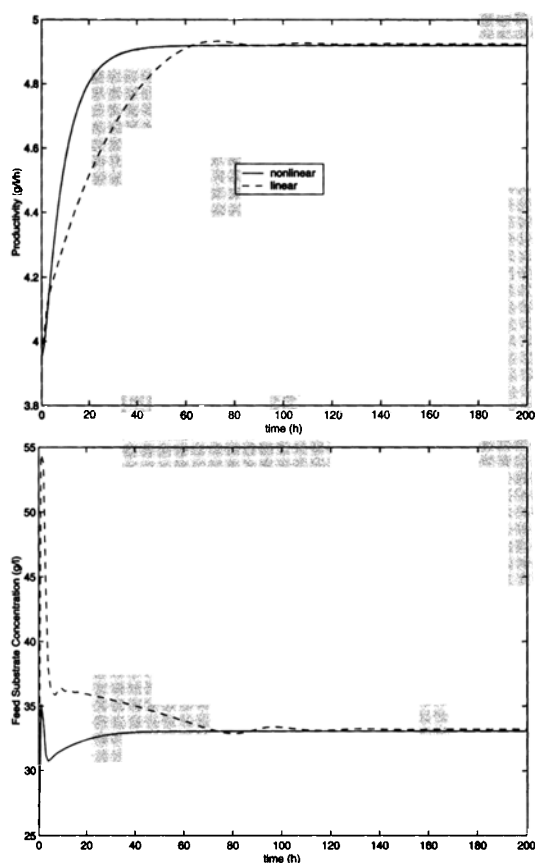

Figure 8: Closed-loop responses under linear and nonlinear controllers—setpoint tracking.

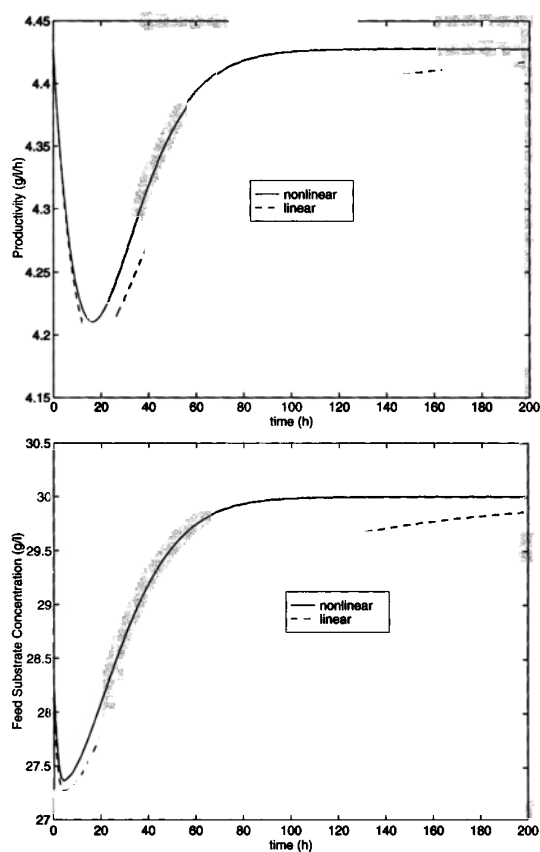

Figure 9: Closed-loop responses under linear and nonlinear controllers—disturbance rejection.

deviations from the setpoint compared to the linear controller

### Concluding Remarks and Future Research

Cell growth systems are characterized by overwhelming complexity and variety. The dynamics of such systems can be described at various levels of detail. In this paper, we focused on continuous reactors used for growth of microbial populations, and presented an overview of recent results in dynamical analysis and control which account directly for the heterogeneous nature of cell populations. These results illustrate the feasibility and advantages of using cell population balance models as the basis for feedback control of bioreactors, and in our view, make a clear case for further research towards the development and practical application of such bioreactor control strategies. The opportunities for scientific and engineering contributions, from a systems and control perspective, in this direction are numerous. Some of these are outlined below

### Cell Population Modeling

The development and validation of cell population balance models for cultures of specific microorganisms (such as yeast), through the combination of flow cytometric measurements and inverse population balance modeling techniques is a key research goal. Analyzing the effect of environmental parameters such as pH, temperature etc. on these functions may also enable using such parameters as additional manipulated variables to achieve a broader range of control objectives, e.g. simultaneously controlling multiple moments of cell property distributions. Finally, the development of structured cell population balance models for specific cultures is the ultimate goal in this direction; such models, although invariably complex, can further broaden the range of control objectives that can be achieved, e.g. controlling metabolic pathways at such a distributed level.

### Dynamic Analysis of Cell Population Models

Despite the fact that cell population balance models have been available for over thirty years, the literature on their dynamics is very sparse. Important open theoretic

cal questions include the existence and stability of both steady-state and periodic solutions. Addressing these questions, either on the basis of the PDE models themselves or on the basis of ODE approximations obtained from spatial discretizations is a key research task. Dynamic simulation is another important tool to address these problems and to investigate other control relevant dynamics such as bifurcations between solutions. Unstructured models are a reasonable starting point for such studies owing to their ability to capture population dynamics with minimal complexity. Analysis of structured models is a considerably more difficult problem but offers the potential to enhance understanding of the complex interactions between individual cell metabolism and cell population dynamics.

### Cell Distribution Control

Further automating and refining on-line flow cytometry and cell staining techniques, to be able to obtain rapid and robust measurements of desired cell property distributions, is clearly an essential task towards the practical application of control laws derived on the basis of cell population balance models. At the level of controller design, translating general operational objectives into specific control objectives involving the measured distribution properties, and evaluating a wide variety of controller design methods with regard to their suitability for these objectives are clearly important tasks that need to be addressed for specific cultures. Integrating sensor development and control algorithm development through laboratory experiments is also necessary to be able to prototype control systems suitable for industrial applications.

In closing we note that much like the results presented in this paper are the outcome of fruitful collaborations between biochemical engineers and control engineers in our respective groups, the future research goals outlined above can be most effectively pursued through such cross-disciplinary collaborations.

### Acknowledgments

We would like to acknowledge Prof. Friedrich Sreenc (Minnesota), Prof. Nikolaos Mantzaris (Rice), and Prof. Martin Hjortso (LSU) for their contributions in the research that generated the results outlined in the paper, as well as for their comments and suggestions on the paper itself. We would also like to acknowledge Prof. Ioannis Kevrekidis and Krishnan Sankaranarayanan (Princeton) for their assistance with the bifurcations calculations.

### References

- Alberghina, L., B. M. Ranzi, D. Porro, and E. Martegani, "Flow Cytometry and Cell Cycle Kinetics in Continuous and Fed-Batch Fermentations of Budding Yeast," *Biotechnol. Prog.*, **7**, 299-304 (1991).
- Bastin, G. and D. Dochain, *On-Line Estimation and Adaptive Control of Bioreactors*. Elsevier Science Publishers (1990).
- Bellgardt, K.-H., "Analysis of Synchronous Growth of Baker's Yeast: Part I: Development of a Theoretical Model for Sustained Oscillations," *J. Biotech.*, **35**, 19-33 (1994).
- Beuse, M., R. Bartling, A. Kopmann, H. Diekmann, and M. Thoma, "Effect of Dilution Rate on the Mode of Oscillation in Continuous Culture of *Saccharomyces cerevisiae*," *J. Biotech.*, **61**, 15-31 (1998).
- Daugulis, A. J., P. J. McLellan, and J. Li, "Experimental Investigation and Modeling of Oscillatory Behavior in the Continuous Culture of *Zymomonas mobilis*," *Biotech. Bioeng.*, **56**, 99-105 (1997).
- Eakman, J. M., A. G. Fredrickson, and H. M. Tsuchiya, "Statistics and Dynamics of Microbial Cell Populations," *Chem. Eng. Prog.*, **62**, 37-49 (1966).
- El Moubarki, J., G. Bastin, and L. Levine, "Nonlinear Control of Biotechnological Processes with Growth-Production Decoupling," *Math. Biosciences*, **116**, 21-44 (1993).
- Fredrickson, A. G. and N. V. Mantzaris, "A New Set of Population Balance Equations for Microbial and Cell Cultures," *Chem. Eng. Sci.* (2002). In press.
- Fredrickson, A. G., D. Ramkrishna, and H. M. Tsuchiya, "Statistics and Dynamics of Prokaryotic Cell Populations," *Math. Biosciences*, **1**, 327-374 (1967).
- Frykman, S., *Single Cell Secretion Rates of Saccharomyces cerevisiae*, PhD thesis, University of Minnesota (1999).
- Godin, F. B., D. G. Cooper, and A. D. Rey, "Development and Solution of a Cell Mass Population Balance Model Applied to the SCF Process," *Chem. Eng. Sci.*, **54**, 565-578 (1999a).
- Godin, F. B., D. G. Cooper, and A. D. Rey, "Numerical Methods for a Population-balance Model of a Periodic Fermentation Process," *AIChE J.*, **45**, 1359-1364 (1999b).
- Hatzis, C., F. Sreenc, and A. G. Fredrickson, "Multistaged Compartmental Models of Microbial Growth: Monte Carlo Simulations," *Biosystems*, **36**, 19-35 (1995).
- Henson, M. A. and D. E. Seborg, "Nonlinear Control Strategies for Continuous Fermentors," *Chem. Eng. Sci.*, **47**, 821-835 (1992).
- Hjortso, M. A. and J. E. Bailey, "Transient Responses of Budding Yeast Populations," *Math. Biosciences*, **63**, 121-148 (1983).
- Hjortso, M. A. and J. Nielsen, "A Conceptual Model of Autonomous Oscillations in Microbial Cultures," *Chem. Eng. Sci.*, **49**, 1083-1095 (1994).
- Hjortso, M. A. and J. Nielsen, "Population Balance Models of Autonomous Microbial Oscillations," *J. Biotech.*, **42**, 255-269 (1995).
- Hjortso, M. A., "Population Balance Models of Autonomous Periodic Dynamics in Microbial Cultures: Their Use in Process Optimization," *Can. J. Chem. Eng.*, **74**, 612-620 (1996).
- Hoo, K. A. and J. C. Kantor, "Global Linearization and Control of a Mixed-Culture Bioreactor with Competition and External Inhibition," *Math. Biosciences*, **82**, 43-62 (1986).
- Jones, K. D. and D. S. Kompala, "Cybernetic Modeling of the Growth Dynamics of *Saccharomyces cerevisiae* in Batch and Continuous Cultures," *J. Biotech.*, **71**, 105-131 (1999).
- Jones, K. D., *Oscillations in Continuous Cultures of Microorganisms: Criteria for Utility of Mathematical Models*, PhD thesis, University of Colorado, Boulder, CO (1995).
- Kim, M.-Y. and E. J. Park, "Mixed Approximation of a Population Diffusion Equation," *Comp. Math. Appl.*, **30**, 5-17 (1995a).
- Kim, M.-Y. and E. J. Park, "An Upwind Scheme for a Nonlinear Model in Age-Structured Population Dynamics," *Comp. Math. Appl.*, **30**, 95-103 (1995b).
- Kim, M.-Y., "Galerkin Methods for a Model of Population Dynamics with Nonlinear Diffusion," *Numerical Methods for Partial Differential Equations*, **12**, 59-73 (1996).

- Kompala, D., N. Jansen, G. Tsao, and D. Ramkrishna, "Investigation of Bacterial Growth on Mixed Substrates: Experimental Evaluation of Cybernetic Models," *Biotech. Bioeng.*, **28**, 1044-1055 (1986).
- Kostova, T. V., "Numerical Solutions of a Hyperbolic Differential-Integral Equation," *Comp. Math. Appl.*, **15**, 427-436 (1988).
- Kostova, T. V., "Numerical Solutions to Equations Modelling Non-linearly Interacting Age-Dependent Populations," *Comp. Math. Appl.*, **19**, 95-103 (1990).
- Kromenaker, S. J. and F. Sreinc, "Effect of Lactic Acid on the Kinetics of Growth and Antibody Production in a Murine Hybridoma: Secretion Patterns During the Cell Cycle," *J. Biotech.*, **34**, 13-34 (1994).
- Kurtz, M. J., G.-Y. Zhu, A. Zamamiri, M. A. Henson, and M. A. Hjortso, "Control of Oscillating Microbial Cultures Described by Population Balance Models," *Ind. Eng. Chem. Res.*, **37**, 4059-4070 (1998).
- Kurtz, M. J., M. A. Henson, and M. A. Hjortso, "Nonlinear Control of Competitive Mixed-Culture Bioreactors via Specific Cell Adhesion," *Can. J. Chem. Eng.*, **78**, 237-247 (2000).
- Kuznetsov, Y. A., *Elements of Applied Bifurcation Theory*. Springer-Verlag, New York, NY (1995).
- Lee, J. M., *Biochemical Engineering*. Prentice-Hall, Englewood Cliffs, NJ (1992).
- Liou, J. J., F. Sreinc, and A. G. Fredrickson, "Solutions of Population Balance Models based on a Successive Generation Approach," *Chem. Eng. Sci.*, **9**, 1529-1540 (1997).
- Mantzaris, N. V., F. Sreinc, and P. Daoutidis, Control of Cell Mass Distribution in Continuous Bioreactors Using Population Balance Models, In *Proceedings of DYCOPS-6*, pages 602-607, Corfu, Greece (1998).
- Mantzaris, N. V., J. J. Liou, P. Daoutidis, and F. Sreinc, "Numerical Solution of a Mass Structured Cell Population Balance Model in an Environment of Changing Substrate Concentration," *J. Biotech.*, **71**, 157-174 (1999).
- Mantzaris, N. V., P. Daoutidis, and F. Sreinc, "Numerical Solution of Multivariable Cell Population Balance Models. I: Finite Difference Methods," *Comput. Chem. Eng.*, **25**, 1411-1440 (2001a).
- Mantzaris, N. V., P. Daoutidis, and F. Sreinc, "Numerical Solution of Multivariable Cell Population Balance Models. II: Spectral Methods," *Comput. Chem. Eng.*, **25**, 1441-1462 (2001b).
- Mantzaris, N. V., P. Daoutidis, and F. Sreinc, "Numerical Solution of Multivariable Cell Population Balance Models. III: Finite Element Methods," *Comput. Chem. Eng.*, **25**, 1463-1481 (2001c).
- Mantzaris, N. V., F. Sreinc, and P. Daoutidis, "Nonlinear Productivity Control using a Multi-Staged Cell Population Balance Model," *Chem. Eng. Sci.*, **57**, 1-14 (2002).
- Mauch, K., S. Arnold, and M. Reuss, "Dynamic Sensitivity Analysis for Metabolic Systems," *Chem. Eng. Sci.*, **52**, 2589-2598 (1997).
- Munch, T., B. Sonnleitner, and A. Fiechter, "New Insights into the Synchronization Mechanism with Forced Synchronous Cultures of *Saccharomyces cerevisiae*," *J. Biotech.*, **24**, 299-313 (1992).
- Muske, K. R. and J. B. Rawlings, "Model Predictive Control with Linear Models," *AIChE J.*, **39**, 262-287 (1993).
- Nielsen, J. and J. Villadsen, "Modelling of Microbial Kinetics," *Chem. Eng. Sci.*, **47**, 4225-4270 (1992).
- Nielsen, J. and J. Villadsen, *Bioreaction Engineering Principles*. Plenum Press, New York, NY (1994).
- Parulekar, S. J., G. B. Semones, M. J. Rolf, J. C. Lievens, and H. C. Lim, "Induction and Elimination of Oscillations in Continuous Cultures of *Saccharomyces Cerevisiae*," *Biotech. Bioeng.*, **28**, 700-710 (1986).
- Pons, M.-N., *Bioprocess Monitoring and Control*. Hanser Publishers, New York (1992).
- Proll, T. and N. M. Karim, "Nonlinear Control of a Bioreactor Model using Exact and I/O Linearization," *Int. J. Control*, **60**, 499-519 (1994).
- Ramkrishna, D., "Statistical Models of Cell Populations," *Adv. Bioch. Eng.*, **11**, 1-47 (1979).
- Ramkrishna, D., "Toward a Self-Similar Theory of Microbial Populations," *Biotech. Bioeng.*, **43**, 138-148 (1994).
- Rawlings, J. B. and W. H. Ray, "Stability of Continuous Emulsion Polymerization Reactors: A Detailed Model Analysis," *Chem. Eng. Sci.*, **42**, 2767-2777 (1987).
- Roels, J. A., *Energetics and Kinetics in Biotechnology*. Elsevier Biomedical Press, Amsterdam, New York, Oxford (1983).
- Sreinc, F. and B. S. Dien, "Kinetics of the Cell Cycle of *Saccharomyces cerevisiae*," *Annals of the New York Academy of Sciences*, pages 59-71 (1992).
- Sreinc, F., Flow Cytometry in Biotechnology: Potential and Limitations, In *Proceedings of ECB6*, pages 13-17 (1993).
- Sreinc, F., "Cytometric Data as the Basis for Rigorous Models of Cell Population Dynamics," *J. Biotech.*, **71**, 233-238 (1999).
- Straight, J. V. and D. Ramkrishna, "Cybernetic Modeling and Regulation of Metabolic Pathways. Growth on Complementary Nutrients," *Biotechnol. Prog.*, **10**, 574-587 (1994).
- Strassle, C., B. Sonnleitner, and A. Fiechter, "A Predictive Model for the Spontaneous Synchronization of *Saccharomyces cerevisiae* Grown in Continuous Culture. II. Experimental Verification," *J. Biotech.*, **9**, 191-208 (1989).
- Subramanian, G. and D. Ramkrishna, "On the Solution of Statistical Models of Cell Populations," *Math. Biosciences*, **10**, 1-23 (1971).
- Sulsky, D., "Numerical Solution of Structured Population Balance Models. II Mass Structure," *J. Math. Biol.*, **32**, 491-514 (1994).
- von Meyenburg, H. K., Stable Synchrony Oscillations in Continuous Culture of *Saccharomyces cerevisiae* under Glucose Limitation, In Chance, B., E. K. Pye, A. K. Shosh, and B. Hess, editors, *Biological and Biochemical Oscillators*, pages 411-417. Academic Press, New York, NY (1973).
- Witkowski, W. R. and J. B. Rawlings, Modelling and Control of Crystallizers, In *Proceedings of American Control Conference*, pages 1400-1405, Minneapolis, MN (1987).
- Yamashit, Y., M. Kuwashim, T. Nonaka, and M. Suzuki, "On-Line Measurement of Cell-Size Distribution and Concentration of Yeast by Image-Processing," *J. Chem. Eng. Japan*, **26**, 615-619 (1993).
- Zhang, Y., A. M. Zamamiri, M. A. Henson, and M. A. Hjortso, "Cell Population Models for Bifurcation Analysis and Nonlinear Control of Continuous Yeast Bioreactors," *J. Proc. Cont.* (2001). In press.
- Zhao, R., A. Natarajan, and F. Sreinc, "A Flow Injection Flow Cytometry System for On-Line Monitoring of Bioreactors," *Biotech. Bioeng.*, **62**, 609-617 (1999).
- Zhu, G.-Y., A. M. Zamamiri, M. A. Henson, and M. A. Hjortso, "Model Predictive Control of Continuous Yeast Bioreactors Using Cell Population Models," *Chem. Eng. Sci.*, **55**, 6155-6167 (2000).